

SERIES MP40 & DERIVATIVES

MP40

MICROSWITCHES

The microswitches MP40 & derivatives are snap-action changeovers, simple switching action, connection by screw lugs.

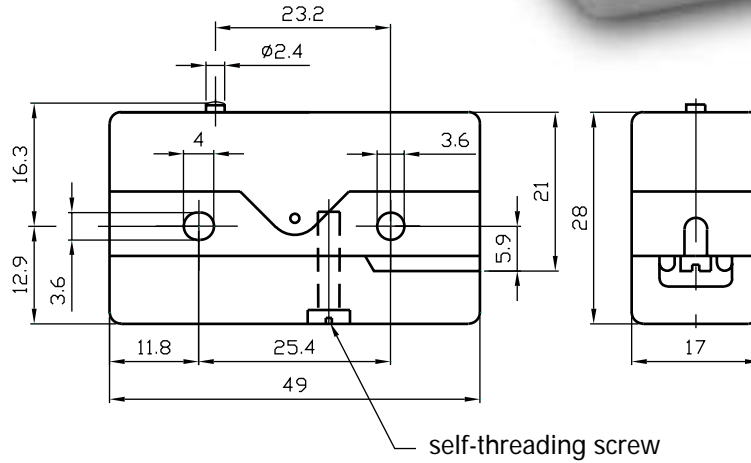

GENERAL CHARACTERISTICS, MODELS MP40

Approval	: 
Switching rating	: 10A 400VAC
Degree of protection	: Housing IP40 Terminals IP00 Cover IP20
Class of protection	: II
Micro-switching	: μ
Distance between contacts	: 0,3 mm
Up to standard	: EN61058-1:92 + A1:93
Frequent functioning	: 50 E3
Mechanical life	: 50 x 10 ⁶ operations
Snap-action mechanism	: Beryllium coppers leaf spring with self-cleaning contacts
Actuators	: Overall dimensions in stainless steel
Dimensions	: DIN 41 635, E-form
Housing	: PA6T/X reinforced with glass fibre Auto-extinguishing according to UL94 V-O
Certified temperature	: - 40°C to +130°C

REFERENCE CODE OF THE ARTICLE

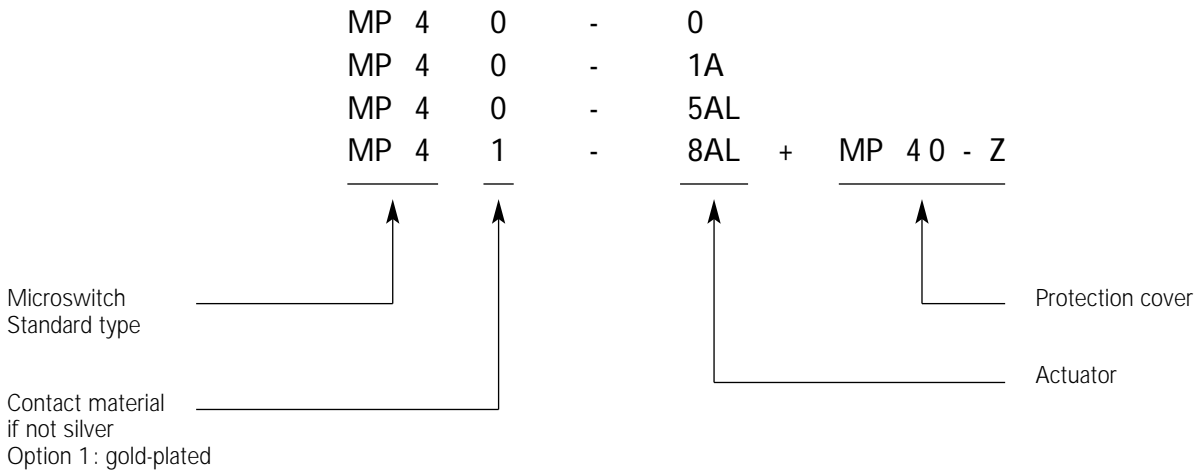

CIRCUIT DIAGRAM

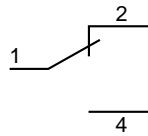

CONNECTION TYPE

MP40
Screw terminals

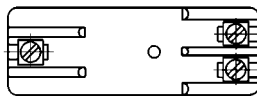

MP50
Terminals with soldering lugs

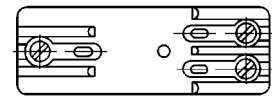

LATERAL FIXING

An **insulating plate** must be inserted between a microswitch with **protruding terminals** and **the fixing surface** if the surface is **metal**

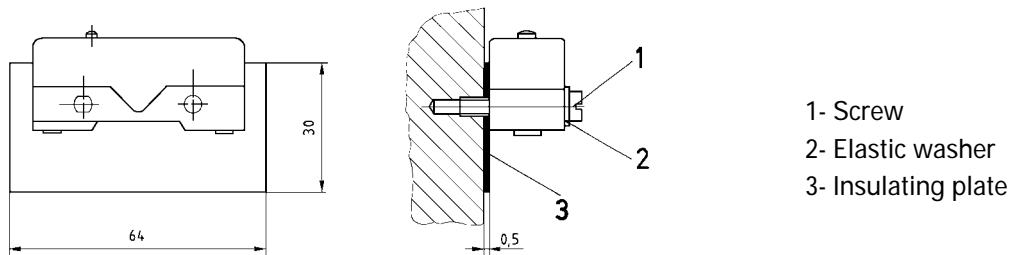

The tightening torque applied to the fixing screws must comply with the following :

Fixing screw	M3	M3.5
Tightening torque in Nm	0.5	0.8

SERIES MP40 & DERIVATIVES

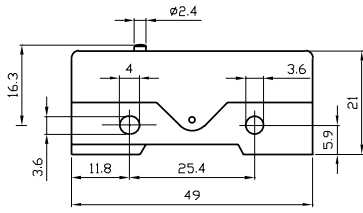
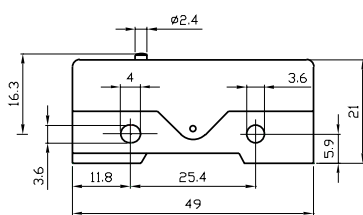
	DESIGNATION	ACTUATING FORCE F_a max. (N)	RELEASE FORCE F_r min (N)	FREE POSITION P_r (mm)	OPERATING POSITION P_a (mm)	OVER-TRAVEL sr min. (mm)	DIFFERENTIAL MOVEMENT sd max. (mm)
	MP40-0 MP50-0	5,0	2,5	$16,3 \pm 0,5$	$15,9 \pm 0,3$	0,25	0,05
	MP44-0	1,5	0,6	$16,3 \pm 0,5$	$15,9 \pm 0,3$	0,25	0,05

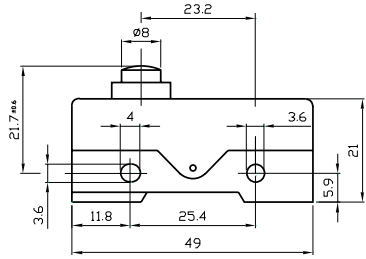
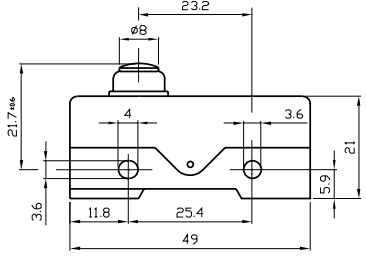

ACTUATING FORCE Fa max. (N)	RELEASE FORCE Fr min (N)	FREE POSITION Pr (mm)	OPERATING POSITION Pa (mm)	OVER-TRAVEL sr min. (mm)	DIFFERENTIAL MOVEMENT sd max. (mm)	DESIGNATION
5,0	2,0	21,7 ± 0,6	21,3 ± 0,3	1,2	0,06	MP61-0
5,0	2,0	21,7 ± 0,6	21,3 ± 0,3	1,2	0,02	*MP61-1-0
5,0	2,0	21,7 ± 0,6	21,3 ± 0,3	1,2	0,10	**MP61-10-0
						
5,0	2,0	21,7 ± 0,6	21,3 ± 0,3	1,0	0,06	MP161-0
5,0	2,0	21,7 ± 0,6	21,3 ± 0,3	1,0	0,02	*MP161-1-0
5,0	1,5	21,7 ± 0,6	21,3 ± 0,3	1,0	0,10	**MP161-10-0
						

* **Reduced contact gap** – 0.20 to 0.25mm.
 Designation «1» after series reference number.
 Example: MP60-1-0, MP61-1-0.
 Differential movement is between 0.01 and 0.02 mm (low hysteresis).
 High repetitive switching precision.
 Reduced switching rating: 110VAC - 15VA max.
 48 VDC - 5W max.

** **Increased contact gap**
 Designation «-10» after series reference number.
 Examples: MP60-10-0, MP161-10-0, MP161-10-0.
 Differential travel is augmented (large hysteresis).

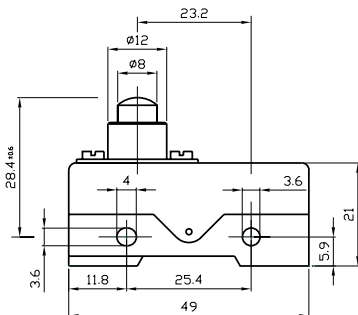
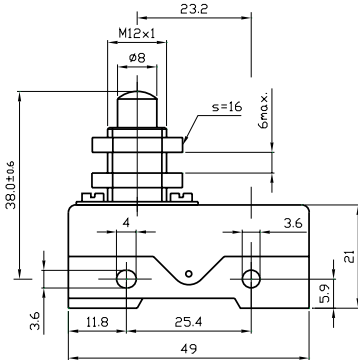
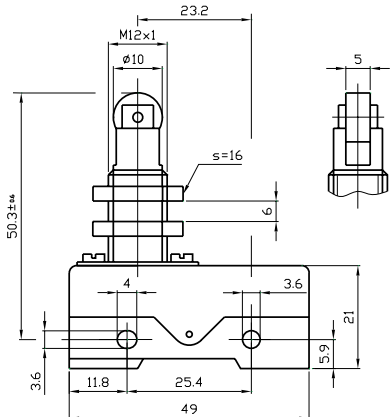
DESIGNATION	ACTUATING FORCE Fa max. (N)	RELEASE FORCE Fr min (N)	FREE POSITION Pr (mm)	OPERATING POSITION Pa (mm)	OVER-TRAVEL sr min. (mm)	DIFFERENTIAL MOVEMENT sd max. (mm)
	5,0	2,5	28,4 ± 0,6	27,9 ± 0,3	2,0	0,05
	5,0	2,5	38,0 ± 0,6	37,5 ± 0,3	5,0	0,05
	5,0	2,5	50,3 ± 0,6	49,8 ± 0,3	5,0	0,05

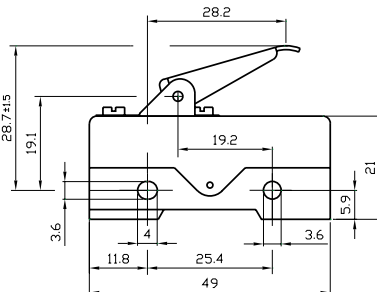
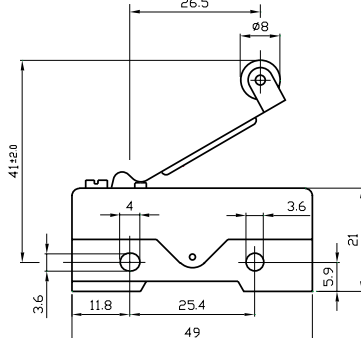
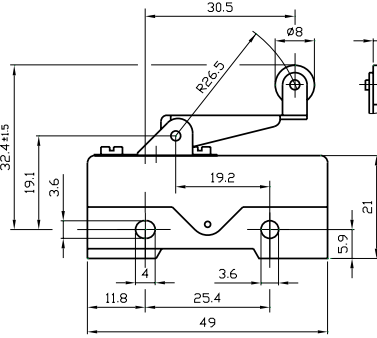
ACTUATING FORCE Fa max. (N)	RELEASE FORCE Fr min (N)	FREE POSITION Pr (mm)	OPERATING POSITION Pa (mm)	OVER-TRAVEL sr min. (mm)	DIFFERENTIAL MOVEMENT sd max. (mm)	DESIGNATION
4,5	1,5	28,7 ± 1,5	26,8 ± 1,5	3,5	0,50	MP40-3A 
2,5	0,7	41,0 ± 2,0	37,0 ± 2,0	2,0	0,80	MP40-4AL 
4,5	1,5	32,4 ± 1,5	30,0 ± 1,5	3,5	0,50	MP40-5AL 

SERIES MP90 & DERIVATIVES

MP90

MICROSWITCHES

The microswitches MP90 & derivatives are snap-action changeovers, simple switching action, connection by screw lugs.

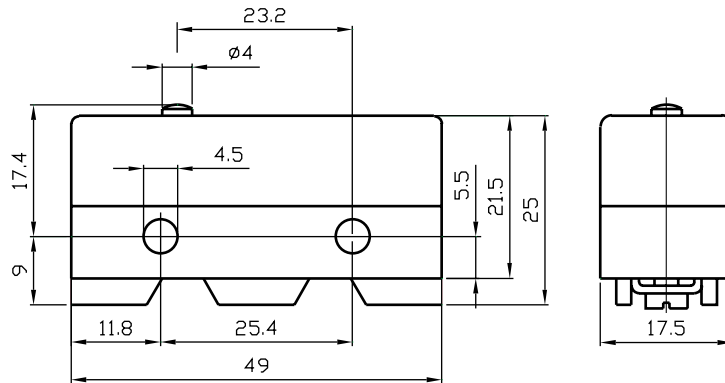

GENERAL CHARACTERISTICS, MODELS MP90

Approval	: 
Switching rating	: 10A 400VAC
Degree of protection	: Housing IP67 Terminals IP00
Class of protection	: II
Micro-switching	: μ
Distance between contacts	: 0,5 mm
Up to standard	: EN61058-1:92 + A1:93
Frequent functioning	: 50 E3
Mechanical life	: 50 x 10 ⁶ operations
Snap-action mechanism	: Beryllium coppers leaf spring with self-cleaning contacts
Actuators	: Overall dimensions in stainless steel
Dimensions	: DIN 41 635, ES-form

SWITCHING DIAGRAM

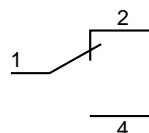

REFERENCE CODE OF THE ARTICLE

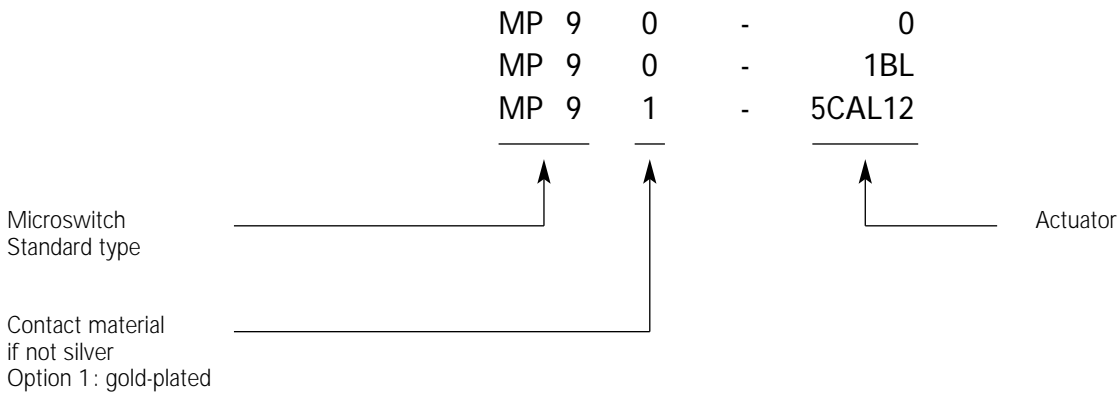

Housing:	PA6T/X reinforced with glass fibre Auto-extinguishing according to UL94V-O Certified temperature	- 40°C to + 130°C
Membrane:	Fluorsilicone rubber MFQ	- 40°C to + 175°C

MP90 DEGREE OF PROTECTION

This type is perfectly sealed: the switching mechanism is completely protected by the housing, which is itself assembled by ultrasonic welding. However, as it has protruding connection terminals which could come in contact with parts of the human body (IEC-529, 1st numeral), it is not eligible for an IP67 approval.

LATERAL FIXING

An **insulating plate** must be inserted between a microswitch with **protruding terminals** and **the fixing surface** if the surface is **metal**

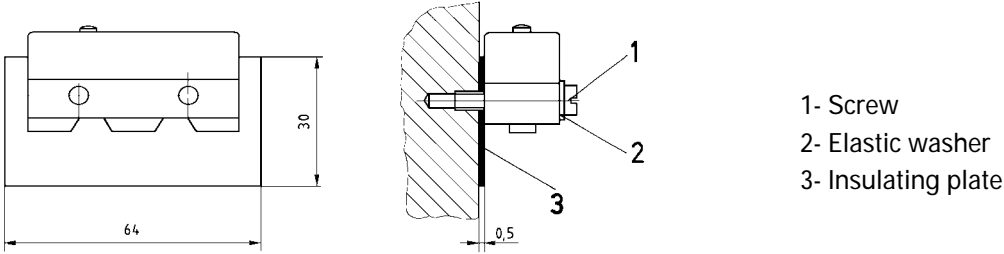

The tightening torque applied to the fixing screws must comply with the following:

Fixing screw	M3	M3.5	M4
Tightening torque in Nm	0.5	0.8	1.2

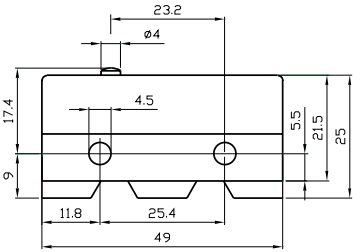
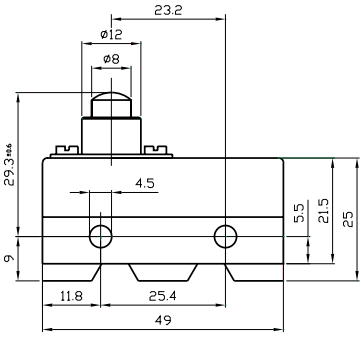
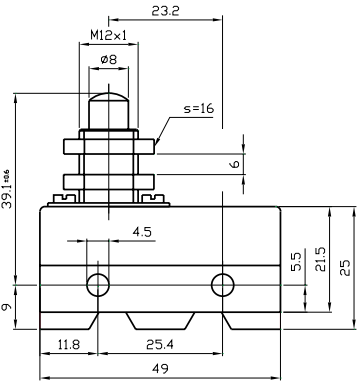
DESIGNATION	ACTUATING FORCE Fa max. (N)	RELEASE FORCE Fr min (N)	FREE POSITION Pr (mm)	OPERATING POSITION Pa (mm)	OVER-TRAVEL sr min. (mm)	DIFFERENTIAL MOVEMENT sd max. (mm)
	6,0	3,0	17,4 ± 0,5	16,7 ± 0,3	0,25	0,06
	6,0	3,0	29,3 ± 0,6	28,5 ± 0,3	2,0	0,08
	6,0	3,0	39,1 ± 0,6	38,4 ± 0,3	5,0	0,08

ACTUATING FORCE Fa max. (N)	RELEASE FORCE Fr min (N)	FREE POSITION Pr (mm)	OPERATING POSITION Pa (mm)	OVER-TRAVEL sr min. (mm)	DIFFERENTIAL MOVEMENT sd max. (mm)	DESIGNATION
6,0	3,0	51,3 ± 0,6	50,6 ± 0,3	5,0	0,08	MP90-1BL MP90-1BLA
4,5	1,2	30,3 ± 1,5	28,5 ± 1,5	3,5	0,50	MP90-3A
4,5	1,2	34,4 ± 1,5	31,9 ± 1,5	3,5	0,60	MP90-5AL

SERIES MP110 & DERIVATIVES

MP110

MICROSWITCHES

MP110 microswitches are snap-action changeovers, simple switching action.

Connections:

- Push-on clips 6.35 x 0.8mm
- Plug-in system of connection MP100-..
- Protective terminal covers MP110-Z..

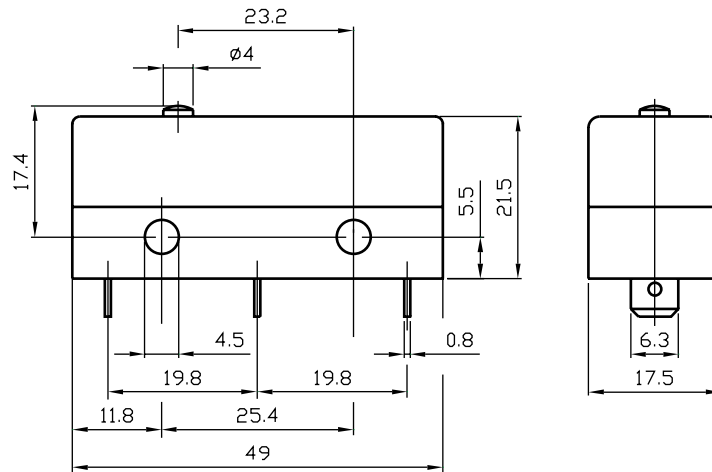

GENERAL CHARACTERISTICS, MODELS MP110

Approval	: 
Switching rating	: 10A 400VAC
Degree of protection	
MP110-0	: Housing IP67 Terminals IP00
MP110-0 + MP100-..	: IP67
MP110-0 + MP110-Z..	: IP64
Class of protection	: II
Micro-switching	: μ
Distance between contacts	: 0,5 mm
Up to standard	: EN61058-1:92 + A1:93
Frequent functioning	: 50 E3
Mechanical life	: 50 x 10 ⁶ operations
Snap-action mechanism	: Beryllium coppers leaf spring with self-cleaning contacts
Actuators	: Overall dimensions in stainless steel
Dimensions	: DIN 41 635, EF-form

SWITCHING DIAGRAM

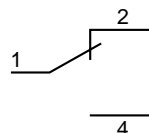

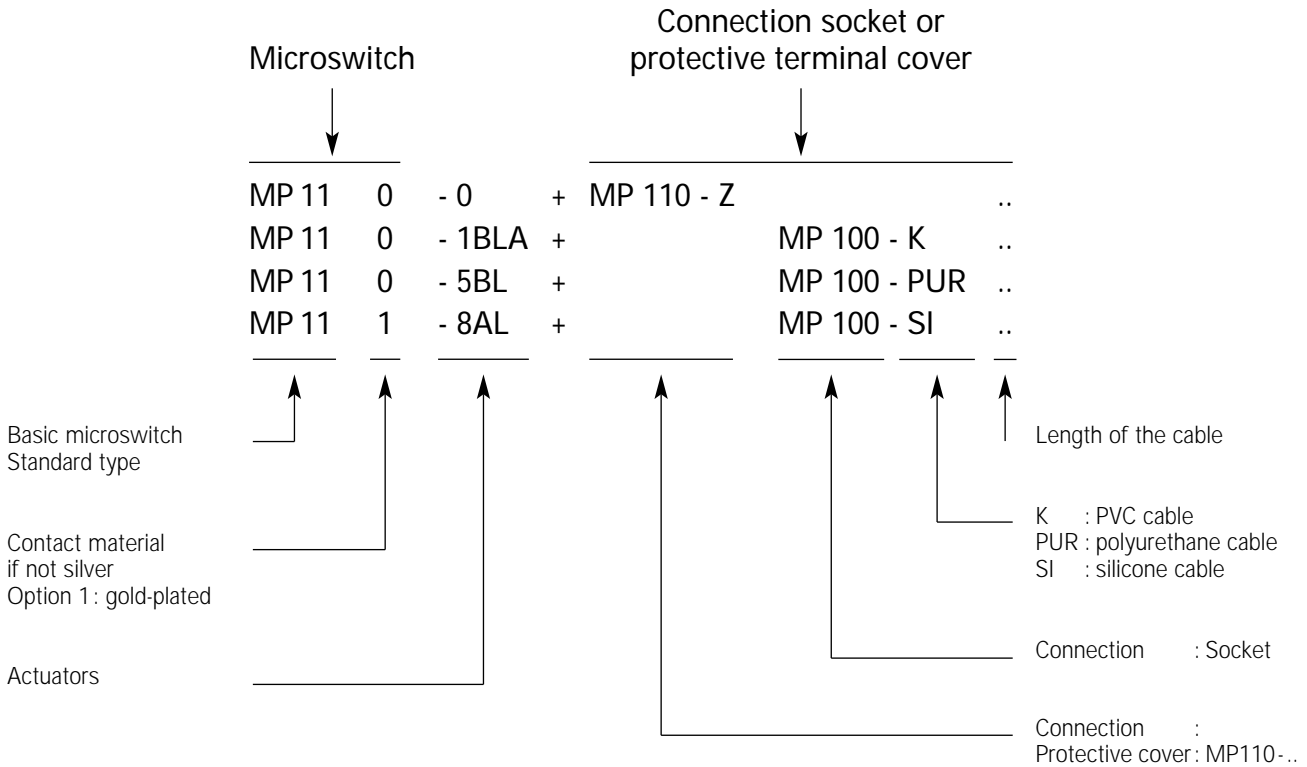

Housing:	PA6T/X reinforced with glass fibre Auto-extinguishing according to UL94V-O Certified temperature	- 40°C to + 130°C
Membrane:	Fluorsilicone rubber MFQ	- 40°C to + 175°C
Cable:	See page 15	

MP110 DEGREE OF PROTECTION

This type is completely sealed: the switching mechanism is completely protected by the housing, which is itself assembled by ultrasonic welding. However, as it has protruding connection terminals, it has to be provided with an accessory system of connection, which can be:

- Plug-in system of connection MP100-.. IP67
- Protective terminal covers MP110-Z.. IP64

SERIES MP100 & DERIVATIVES

MP100

PLUG-ON CONNECTION SOCKET

The plug-on connection sockets MP100 and derivatives can be fixed on our MP110 and derivatives microswitches.

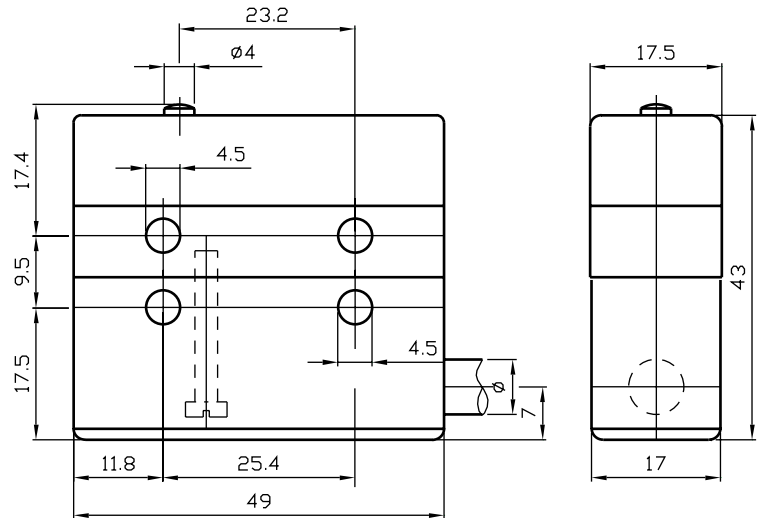
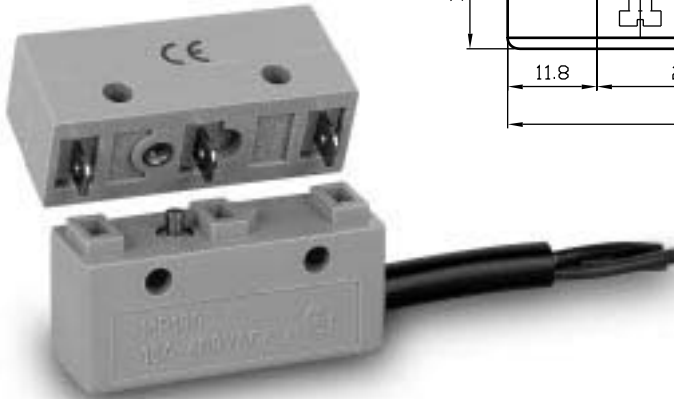

TECHNICAL CHARACTERISTICS, TYPES MP100

The plug-on connection socket MP100-.. guarantees full protection, in accordance with degree-of-protection standard IP67, by means of a system of 3 sealing rings fitted into the microswitch. The assembly is held together and secured by means of an M3 screw housed in the socket unit. This unit is sealed.

Approval	: 
Degree of protection	: IP67
Connection	: Overmoulded cable

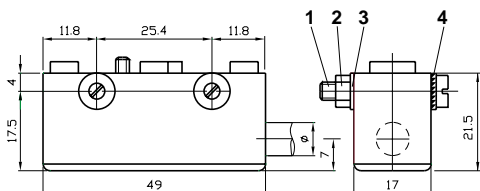
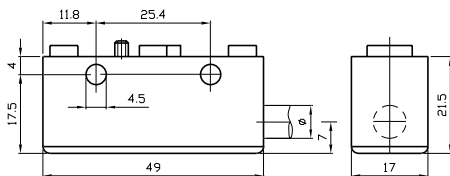

MP100 or MP101 type fitting

The MP110+MP100-.. assembly can be mounted by the socket, which means that the socket can be fitted firstly and the switch inserted subsequently.

A spacing washer will have to be inserted to take up the difference in thickness between the switch (17.5mm) and the socket (17.0mm).

MP101-.. comprises the following fixing element:

- 1 - Fixing screw M4x25 – A2 stainless steel
- 2 - Nut M4
- 3 - Spacing washer s=0.8mm $\varnothing 4.3$ mm
- 4 - Serrated locking washer $\varnothing 4.3$ mm

Moulding torque for = 1.2Nm

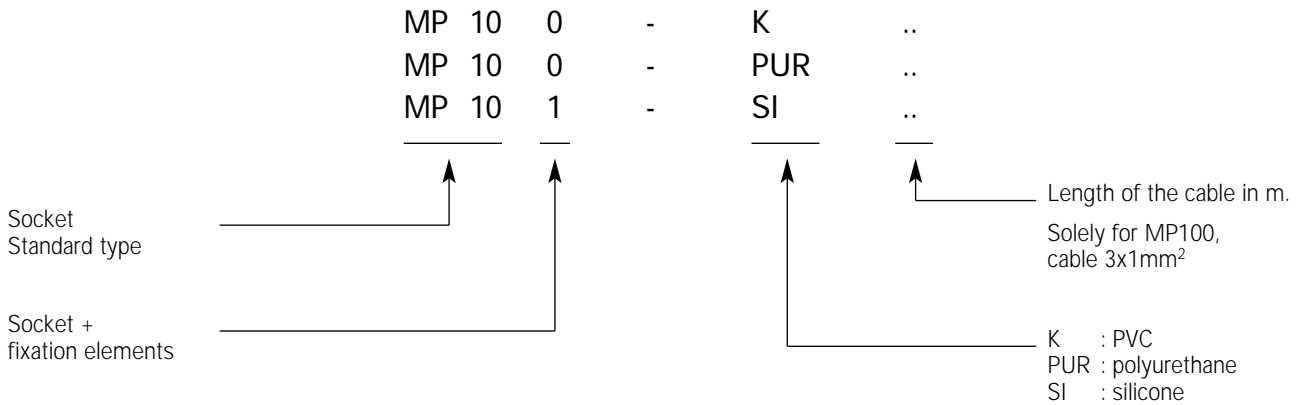

Designation	Switching diagram	Housing and connecting cable for MP100-.. socket
Housing:		PA6T/X reinforced with glass fibre Auto-extinguishing according to UL94V-O Certified operating temperatures: - 40°C to + 130°C
MP100-K..		PVC, 3x1.0 mm ² , black coating External diameter: 7.3 mm Operating temperatures: - 20°C to + 70°C Thermoplastic synthetic material, standard for general use Good mechanical and electrical properties.
MP100-PUR..		PUR, 3x1.0 mm ² , grey coating External diameter: 7.3 mm Operating temperatures: - 40°C to + 90°C High tear, crushes and puncture resistance. Good resistance to mineral oils Good flexibility even at low temperatures
MP100-SI..		SI, 3x1.0 mm ² , white coating External diameter: 7.3 mm Operating temperatures: Mobile - 25°C to + 150°C Fixed - 40°C to + 150°C Max. in water + 100°C Synthetic silicone rubber. Excellent resistance to low and high temperatures. Ages well.
MP100- ?		We overmould with other types of cables as long as their characteristics are in accordance with the standards we apply to our products.

According to the availability of the market we reserve ourselves the right to modify the colors of identification of wire connection.

SERIES MP110-Z.. & DERIVATIVES

MP110-Z..

PROTECTIVE TERMINAL COVER

The protective terminal covers and derivatives are fixed on our MP110 microswitches and derivatives.

They have 3 possible outlets, A, B or C as shown on the drawing below.

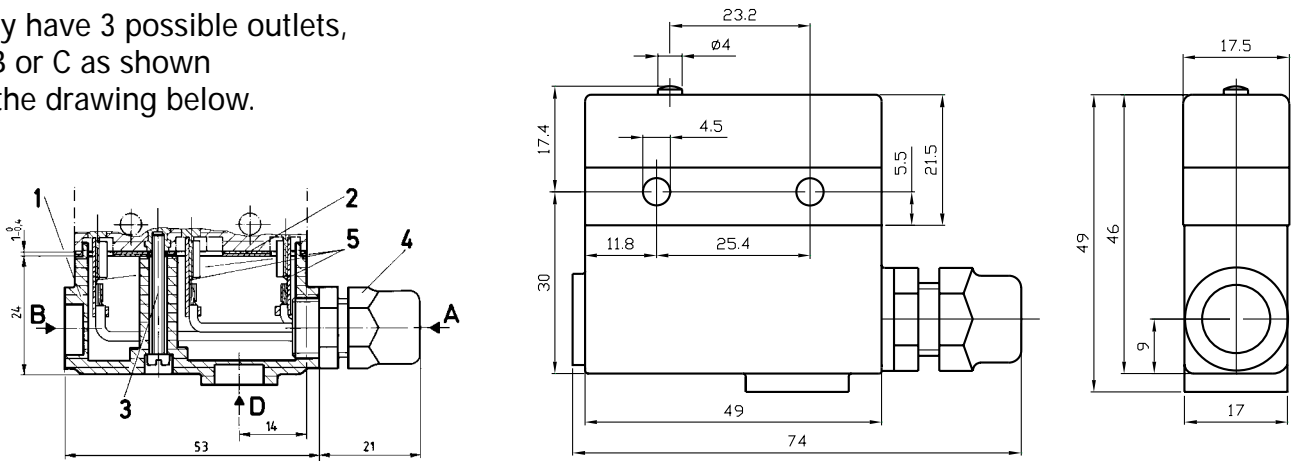

TECHNICAL CHARACTERISTICS, TYPES MP110-Z..

The protective terminal covers MP110-Z.. (pos.1) can be used with any type of connecting cable. Fixed on a MP110, it guarantees a degree of protection in accordance with standard IP64. A sealing gasket, which is compressed between the switch MP110 and the terminal cover MP110-Z by tightening the fixing screw (pos.2), guarantees the tightness of the whole.

- Approval : 
- Degree of protection : IP64
- Connection : 3 – 6.35x0.8 mm push-on tags (pos.5) to rivet on the wires.

DESIGNATION AND DESCRIPTION OF VARIANTS OF THE MP110-Z

Designation	Description
MP110-ZA MP110-ZB MP110-ZD	Only one outlet is tapped to take the PG7. The other two remain blocked.
MP110-ZA3 MP110-ZB3 MP110-ZD3	All three outlets are tapped to take the PG7. The MP110-Z is supplied with two sealing plugs for the unused outlets. The A, B or D indicates which outlet is open.
MP110-ZAPG7 MP110-ZBPG7 MP110-ZDPG7	According to the designation, only one outlet is fitted with a PG7. The others remain blocked.
MP110-ZA3PG7 MP110-ZB3PG7 MP110-ZD3PG7	All three outlets are tapped to take the PG7. According to the designation, one is fitted with a PG7, the other two with sealing plugs.

Housing:	PA6T/X reinforced with glass fibre Auto-extinguishing according to UL94V-O Certified temperature	- 40°C to + 130°C
Sealing gasket:	Silicone (SI)	- 40°C to + 150°C
PG7 stuffing box: (cable gland)	Polyamide with glass fibre	- 20°C to + 100°C

SWITCHING CHARACTERISTICS OF THE MP110 AND DERIVATIVES

ACTUATING FORCE Fa max. (N)	RELEASE FORCE Fr min (N)	FREE POSITION Pr (mm)	OPERATING POSITION Pa (mm)	OVER-TRAVEL sr min. (mm)	DIFFERENTIAL MOVEMENT sd max. (mm)	DESIGNATION
6,0	3,0	17,4 ± 0,5	16,6 ± 0,3	0,25	0,06	MP110-0
6,0	3,0	17,4 ± 0,5	16,8 ± 0,3	0,25	0,02	*MP120-1-0
6,0	2,5	17,4 ± 0,5	16,7 ± 0,3	0,25	0,10	**MP120-10-0
6,0	3,0	29,3 ± 0,6	28,5 ± 0,3	2,0	0,08	MP110-1S29

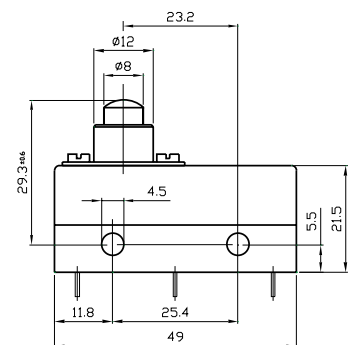
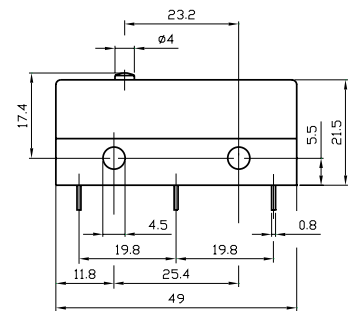

* **Reduced contact gap** – 0.20 to 0.25mm.
Designation «1» after series reference number.
Example: MP120, MP120-1-0.
Differential movement is between 0.01 and 0.02 mm (low hysteresis).
High repetitive switching precision.
Reduced switching rating: 110VAC - 15VA max.
48 VDC - 5W max.

** **Increased contact gap**
Designation «-10» after series reference number.
Examples: MP120-10-0.
Differential travel is augmented (large hysteresis).

SERIES MP110 & DERIVATIVES

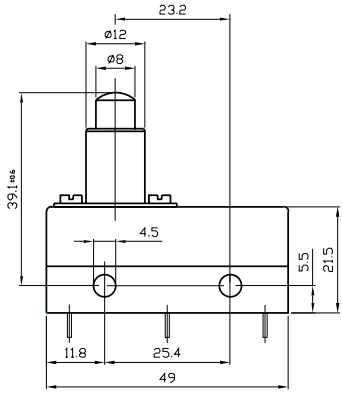
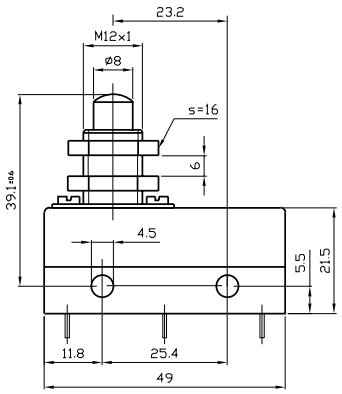
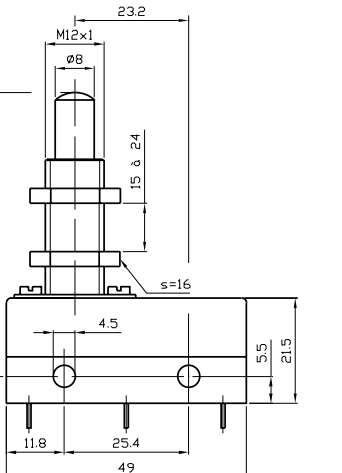
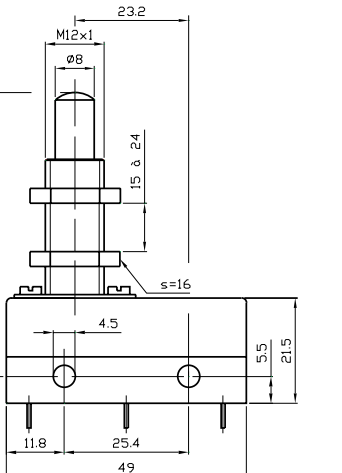
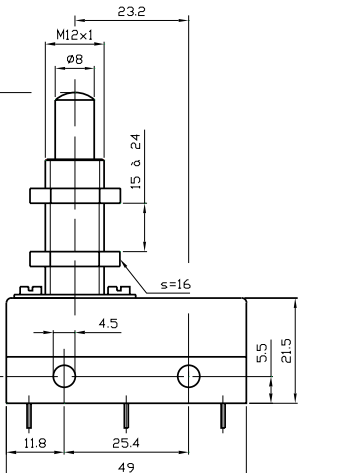
DESIGNATION	ACTUATING FORCE Fa max. (N)	RELEASE FORCE Fr min (N)	FREE POSITION Pr (mm)	OPERATING POSITION Pa (mm)	OVER-TRAVEL sr min. (mm)	DIFFERENTIAL MOVEMENT sd max. (mm)
	6,0	3,0	39,1 ± 0,6	38,4 ± 0,3	5,0	0,08
	6,0	3,0	39,1 ± 0,6	38,4 ± 0,3	5,0	0,08
	6,0	2,5	58,0 ± 1,0	57,3 ± 0,3	10,0	0,10
	6,0	2,5	82,6 ± 1,0	82,1 ± 0,3	20,0	0,10
	6,0	2,5	64,0 ± 0,6	63,3 ± 0,3	5,0	0,10

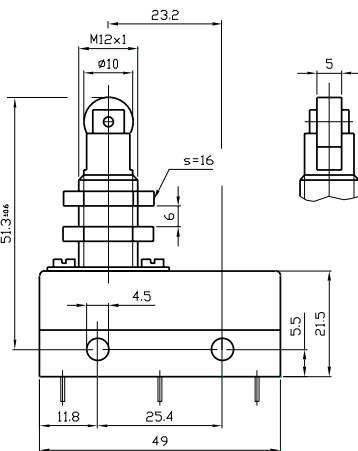
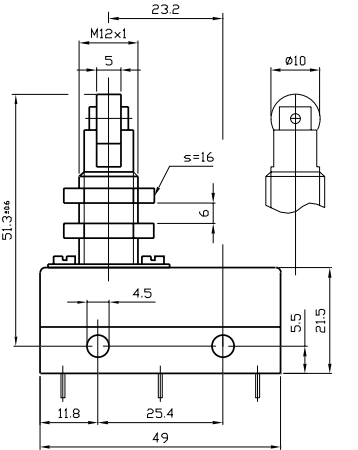
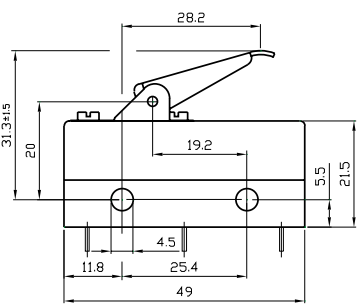
ACTUATING FORCE Fa max. (N)	RELEASE FORCE Fr min (N)	FREE POSITION Pr (mm)	OPERATING POSITION Pa (mm)	OVER-TRAVEL sr min. (mm)	DIFFERENTIAL MOVEMENT sd max. (mm)	DESIGNATION
6,0	3,0	51,3 ± 0,6	50,6 ± 0,3	5,0	0,08	MP110-1BL
6,0	3,0	51,3 ± 0,6	50,6 ± 0,3	5,0	0,08	MP110-1BLA
						
6,0	3,0	51,3 ± 0,6	50,6 ± 0,3	5,0	0,08	MP110-1BT
6,0	3,0	51,3 ± 0,6	50,6 ± 0,3	5,0	0,08	MP110-1BTA
						
4,5	1,2	31,3 ± 1,5	29,3 ± 1,5	3,5	0,50	MP110-3A
						

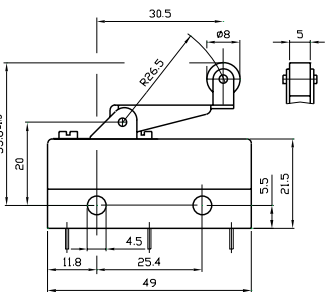
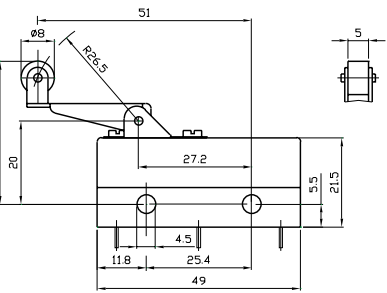
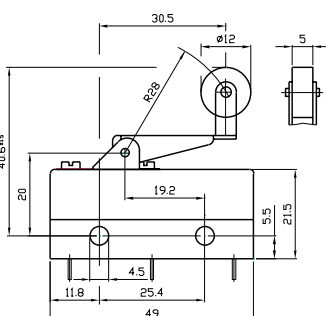
DESIGNATION	ACTUATING FORCE Fa max. (N)	RELEASE FORCE Fr min (N)	FREE POSITION Pr (mm)	OPERATING POSITION Pa (mm)	OVER-TRAVEL sr min. (mm)	DIFFERENTIAL MOVEMENT sd max. (mm)
 <p>MP110-5AL</p>	4,5	1,2	35,8 ± 1,5	33,0 ± 1,5	3,5	0,60
 <p>MP110-5BL</p>	4,5	1,2	35,8 ± 1,5	33,0 ± 1,5	3,5	0,60
 <p>MP110-5CAL12</p>	4,5	1,2	40,6 ± 1,5	37,8 ± 1,5	3,5	0,60

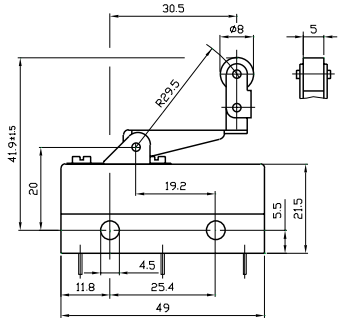
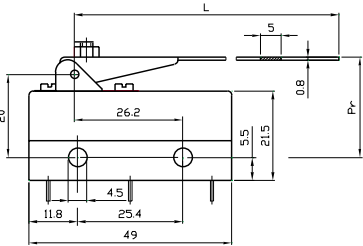
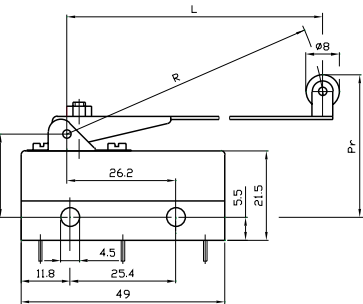
ACTUATING FORCE F_a max. (N)	RELEASE FORCE F_r min (N)	FREE POSITION P_r (mm)	OPERATING POSITION P_a (mm)	OVER-TRAVEL sr min. (mm)	DIFFERENTIAL MOVEMENT sd max. (mm)	DESIGNATION
4,5	1,2	41,9 ± 1,5	39,0 ± 1,5	3,5	0,60	MP110-6AL 
0.2	0,05	-	-	-	3,00	MP110-7A120 
0.4	0,1	-	-	-	1,50	MP110-7A63,5
0.6	0,2	-	-	-	0,80	MP110-7A40
0.2	0,05	-	-	-	3,00	MP110-8AL120 
0.4	0,1	-	-	-	1,50	MP110-8AL63,5
0.6	0,2	-	-	-	0,80	MP110-8AL40

SERIES MP210 & DERIVATIVES

MP210

MICROSWITCHES

IP67 & IP68

The microswitches MP210 & derivatives are snap-action changeovers, simple or double switching action, connection by directly overmoulded cable. By wiring the 5 terminals in different combinations, you can obtain electrical circuits to 3, 4 or 5 wires.

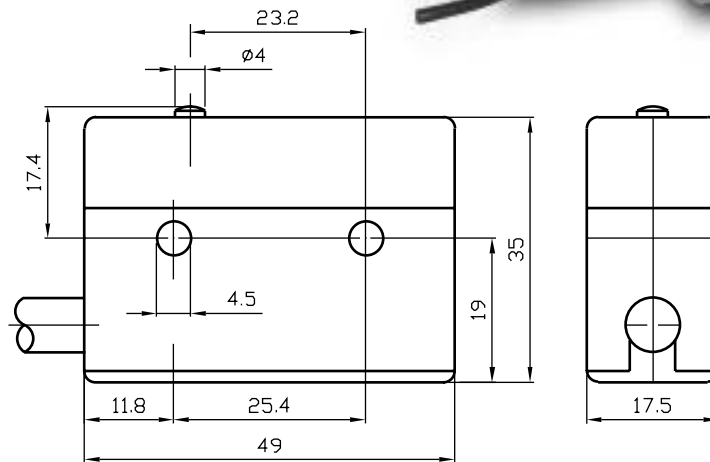

GENERAL CHARACTERISTICS, MP210 TYPES

Approval,	:	 , 10A (2 x 5) 250VAC
switching rates	:	CSA , 6A 250VAC, 0,5A 125VDC, 0,25A 250VDC
Degree of protection, MP210	:	IP67
MP215	:	IP68
Class of protection	:	II
Micro-switching	:	μ
Contact-gap	:	0,8 mm
Up to standard	:	EN61058-1:92 + A1:93
Frequent functioning	:	50 E3
Mechanical life	:	50 x 10 ⁶ operations
Snap-action mechanism	:	Beryllium coppers leaf spring with self-cleaning contacts
Actuators	:	Overall dimensions in stainless steel
Dimensions	:	DIN 41 635, E-form

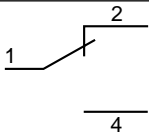
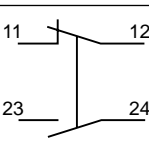
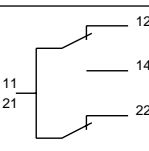
<p>CHANGEOVER</p> <p>The fixed contact terminals are wired in parallel when the cable is connected. The two closed contacts (12) and (22), on the one hand, and the two open contacts (14) and (24), on the other, form a changeover with terminal (1) in common. this arrangement of parallel contacts doubles the reliability of the switch</p>	<p>Designation : MP210-0/3..</p> 
<p>OFF-ON CIRCUIT</p> <p>Here, the common terminal is not wired producing two separate circuits with no common terminal. The strip merely switches between the fixed contacts. This variant is recommended for heavy loads because of the simultaneous opening of a double contact gap.</p>	<p>Designation : MP210-0/4..</p> 
<p>GENERAL CIRCUIT</p> <p>In this version, the overmoulded cable is wired to all of the connecting terminals thus allowing for all possibilities which makes it particularly suitable for prototype development and testing purposes. However, the cable is more rigid and the diameter approaching 9.0mm.</p>	<p>Designation : MP210-0/5..</p> 

REFERENCE CODE OF THE ARTICLE

SERIES MP210 & DERIVATIVES

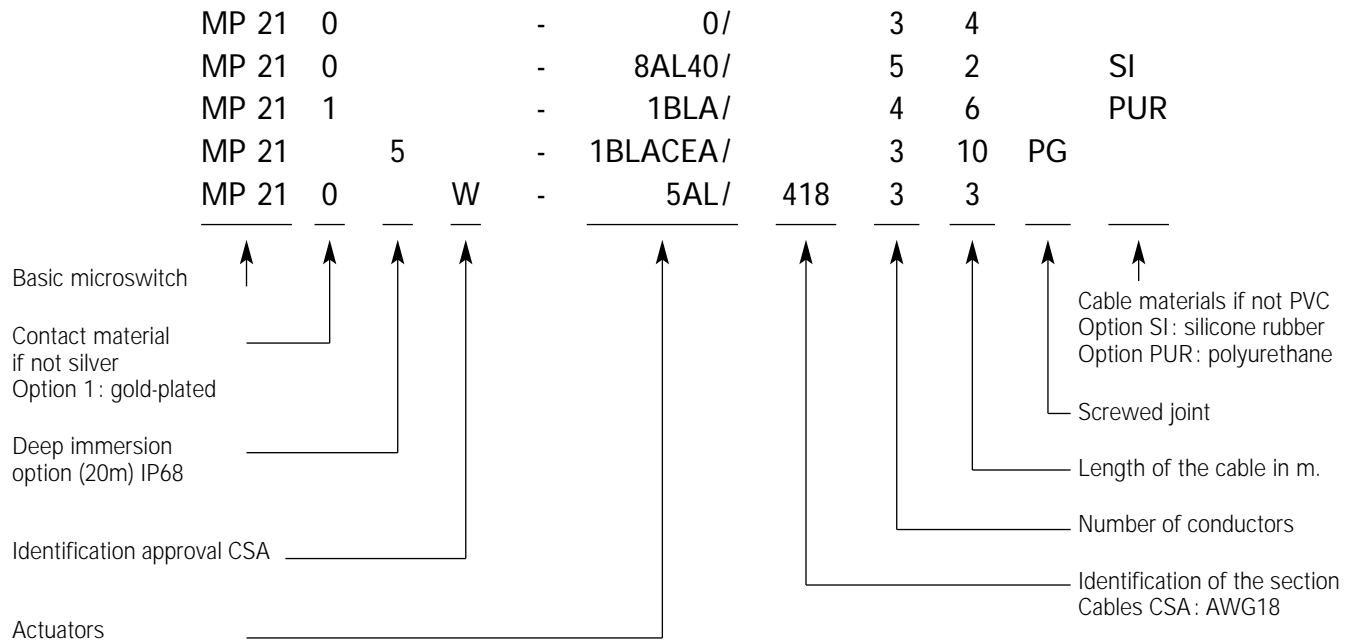

Housing:	PA6T/X reinforced with glass fibre Auto-extinguishing according to UL94V-O Certified temperature	- 40°C to + 130°C
Membrane:	Fluorsilicone rubber MFO	- 40°C to + 175°C
Cable:	PVC SI Silicone rubber PUR polyurethane rubber	- 20°C to + 70°C - 40°C to + 150°C - 40°C to + 90°C

DESCRIPTION AND MICROSWITCHES SWITCHING DIAGRAMS, SERIES MP210

DESIGNATION OF CONNECTION CABLES	POLYVINYLE CHLORID (PVC)	POLYURETHANE Designation: PUR	SILICONE Designation: SI
Designation	MP210-0/3..	MP210-0/3..PUR	MP210-0/3..SI
Changeover			
Designation	MP210-0/4..	MP210-0/4..PUR	MP210-0/4..SI
OFF-ON Switch			
Designation	MP210-0/5.. or -0/5..PUR		
General Circuit Coloured Leads or Numbered Leads			
	<p><i>According to the availability of the market we reserve ourselves the right to modify the colors of identification of wire connection.</i></p>		

MP210 MICROSWITCH – REVERSE CABLE OUTLET

Designation «S»

DESIGNATION: MP210-0/...S

The cable outlet on the MP210 series of microswitches is reversed as compared to that on the MP110-0 + MP100 socket assembly. In order that the two units may be interchangeable, the dimension of the microswitch fixing holes being the same, the cable outlet can be reversed in the MP210 series.

This variation can be effected only with the following models:

- MP210-0/3.. Changeover switch becomes : MP210-0/3..S
- MP210-0/4.. Off-On switch becomes : MP210-0/4..S

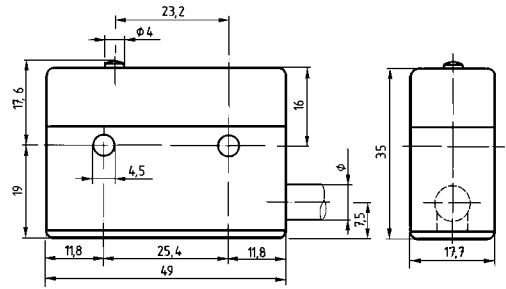

MP210 SERIES SEALED MICROSWITCH + STUFFING BOX (CABLE GLAND)

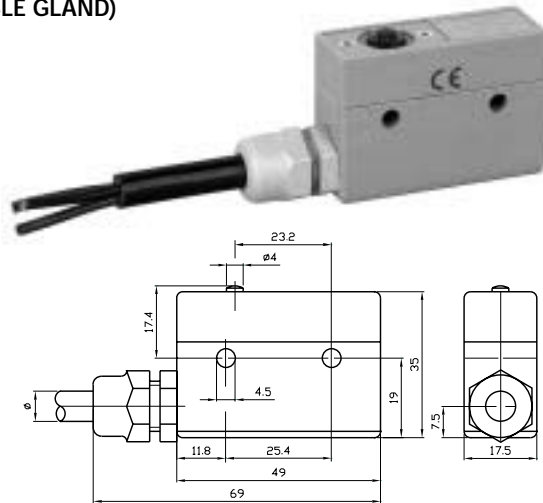

MP210-0/.. PG

For severe operating conditions, when the length of cables used is considerable and the cable is subject to tugging and twisting strains where it leaves the switching housing, we recommend that the switch outlet be fitted with a stuffing box (cable gland). In certain environments (such as attack by chemical agents) where the diameter of the cable may alter, this ensures a constant degree of protection.

STUFFING BOX: Type PG7
 (CABLE GLAND) Glass-fibre reinforced Polyamide, light grey
 Washer of Perbunan N.
 Temperature: -20°C to + 80°C

This variant is not possible for cables with a diameter in less of 7.5mm.

MP210 SERIES SEALED MICROSWITCH APPROVAL CSA

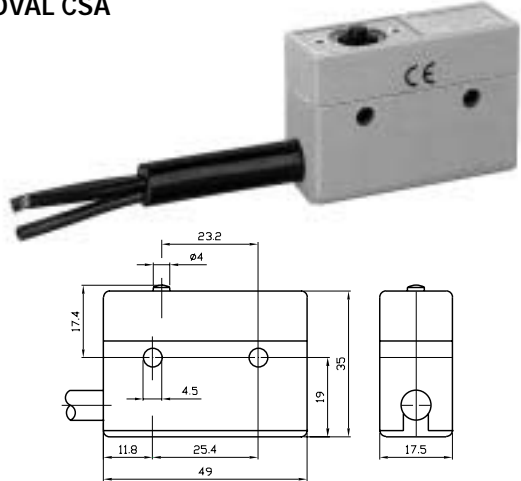

MP210W-0/418/3..

A variant on the standard model overmoulded with a connection cable according to CSA standard. Thus, the whole could be approved according to CSA standard of which we have the certificate at disposal.

The dimension is identical and the MP210W-0/418/3.. can receive the complete range of our actuators.

DESCRIPTION DESIGNATION	SWITCHING DIAGRAM	DESCRIPTION DESIGNATION	SWITCHING DIAGRAM
<p>MP210-0/3.PG</p> <p>For use with standard 3x1mm² cables. Switching rating: 10 A 250 VAC</p>		<p>MP210W-0/418/3..</p> <p>Connecting cable sheath neoprene black, type SJOW conductors AWG18</p> <p>Switching rating: 6 A 250 VAC</p> <p>Temperatures -40°C to +90°C</p> <p>The green conductor is not used</p>	
<p>MP210-0/475/4.. PG</p> <p>For use with standard 4x0.75 mm² cables. Switching rating: 6 A 250 VAC</p>		<p>Command characteristics opposite, page 25</p>	

CHARACTERISTICS OF COMMAND SERIES MP210 – MICROSWITCH MP215 CONTINUOUS IMMERSION IP68

GENERAL CHARACTERISTICS

We can supply a microswitch of the same dimensions as the MP210-0/3.PG that is a variant thereon and which requires an increased actuating force making it suitable for operation under several meters of liquid – generally water. The reason for this increased force is that, at a certain depth, the pressure of the water on the membrane can cause a switch with a normal actuating force to operate automatically.

- Approvals : 
- Switching rating : 10A (2x5) 250VAC
- Mechanical life : 10 x 10⁶ operations
- Connection : Over-moulded cable with PG7 stuffing box (cable gland).
Does not exist for general circuit, 5 leads.
- Degree of protection : **IP68**
Maximum immersion depth of **20 m in water**.
- Actuators : Use only telescopic plungers.
ATTENTION: modified internal mechanism – Code **CEA**
Amended designation: **1BLACEA, 1ACEA**

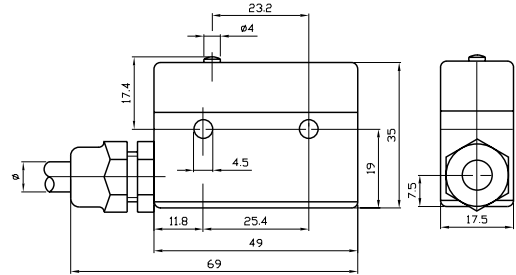

MP215-0/3.PG

ACTUATING FORCE Fa max. (N)	RELEASE FORCE Fr min (N)	FREE POSITION Pr (mm)	OPERATING POSITION Pa (mm)	OVER-TRAVEL sr min. (mm)	DIFFERENTIAL MOVEMENT sd max. (mm)	DESIGNATION
12,5	6,0	51,4 ± 0,6	50,4 ± 0,3	5,0	0,12	MP215-1BLACEA/..PG
12,5	6,0	17,4 ± 0,5	16,5 ± 0,3	0,25	0,10	MP215-0/..
6,0	2,5	17,4 ± 0,5	16,5 ± 0,3	0,25	0,10	MP210W-0/418/3..
6,0	2,2	17,4 ± 0,5	16,5 ± 0,3	0,25	0,10	MP210-0/..

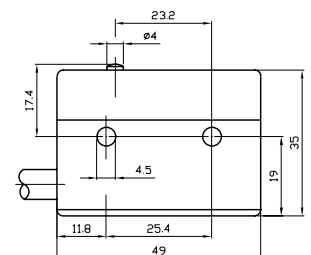
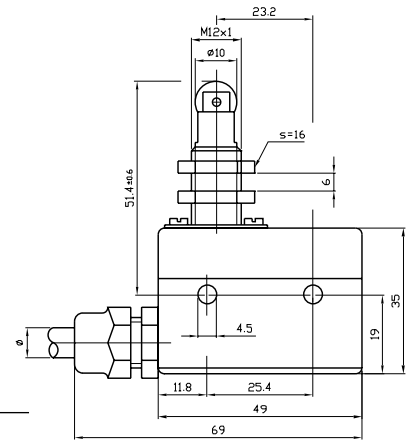

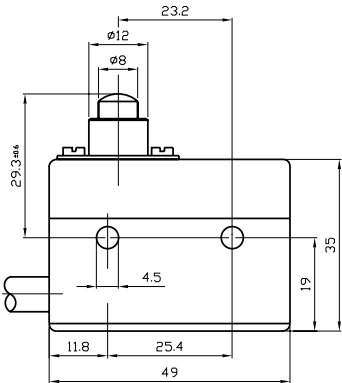
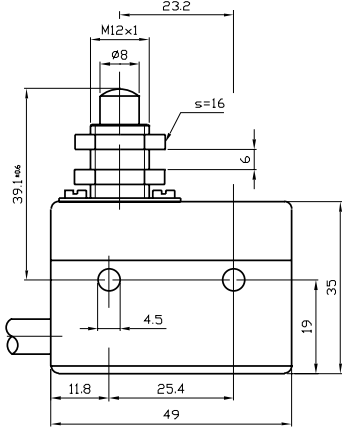
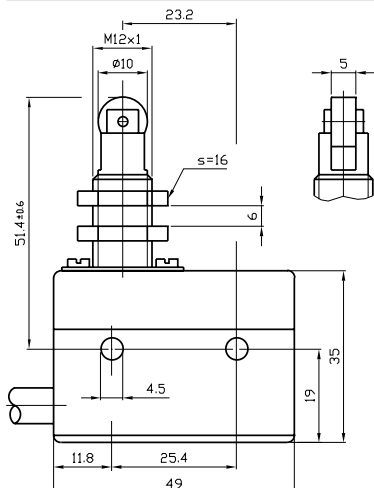
DESIGNATION	ACTUATING FORCE Fa max. (N)	RELEASE FORCE Fr min (N)	FREE POSITION Pr (mm)	OPERATING POSITION Pa (mm)	OVER-TRAVEL sr min. (mm)	DIFFERENTIAL MOVEMENT sd max. (mm)
 <p>MP210-1S29/..</p>	6,0	2,5	29,3 ± 0,6	28,4 ± 0,3	2,0	0,12
 <p>MP210-1A/..</p>	6,0	2,5	39,1 ± 0,6	38,3 ± 0,3	5,0	0,12
 <p>MP210-1BL/..</p>	6,0	2,5	51,4 ± 0,6	50,7 ± 0,3	5,0	0,12

ACTUATING FORCE Fa max. (N)	RELEASE FORCE Fr min (N)	FREE POSITION Pr (mm)	OPERATING POSITION Pa (mm)	OVER-TRAVEL sr min. (mm)	DIFFERENTIAL MOVEMENT sd max. (mm)	DESIGNATION
4,5	1,2	31,1 ± 1,5	29,0 ± 1,5	3,5	0,80	MP210-3A/..
4,5	1,2	35,5 ± 1,5	32,5 ± 1,5	3,5	0,90	MP210-5AL/..
4,5	1,2	41,6 ± 1,5	38,6 ± 1,5	3,5	0,90	MP210-6AL/..

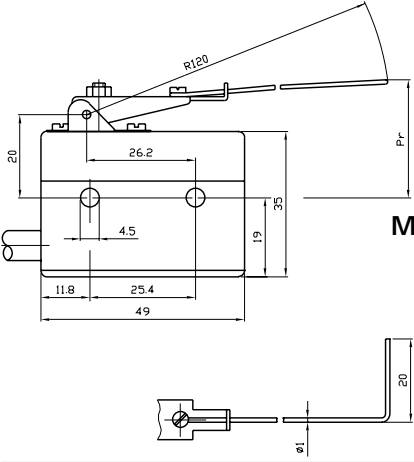
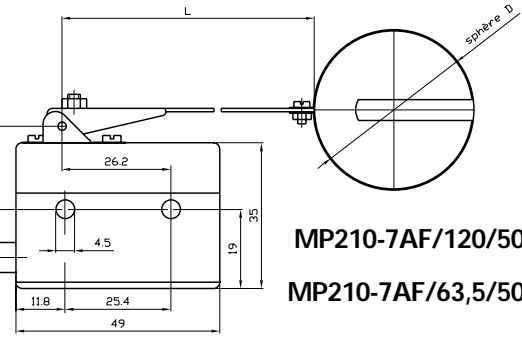
DESIGNATION	ACTUATING FORCE Fa max. (N)	RELEASE FORCE Fr min (N)	FREE POSITION Pr (mm)	OPERATING POSITION Pa (mm)	OVER-TRAVEL sr min. (mm)	DIFFERENTIAL MOVEMENT sd max. (mm)
 <p>MP210-7C/..</p>	0,2	0,05	-	-	-	5,00
 <p>MP210-7AF/120/50/.. MP210-7AF/63,5/50/..</p>	-	-	-	-	-	4,00 2,00

ACTUATORS, SERIES 7F – LEVER WITH FLOAT

In this variant, a polypropylene float is mounted in an 18/8 stainless spring steel harness fixed to the end of lever 7.

The assembly is used lever downwards which means that it releases the actuator button of the microswitch by means of its own weight and can thus be used to control the lever of a liquid, to ensure safety of a filling process or to give an alarm in case of overflow.

Adapting the length of the lever or the diameter of the float can vary the sensitivity of the assembly. Regulating the screw on the lever arm can set the final level.

Designation: 7F/63.5/50
7F/120/50

Temperature max.: 100°C

ACTUATING FORCE Fa max. (N)	RELEASE FORCE Fr min (N)	FREE POSITION Pr (mm)	OPERATING POSITION Pa (mm)	OVER-TRAVEL sr min. (mm)	DIFFERENTIAL MOVEMENT sd max. (mm)	DESIGNATION
0.2	0,05	-	-	-	4,00	MP210-8AL120/..
0.4	0,1	-	-	-	2,00	MP210-8AL63,5/..
0.6	0,2	-	-	-	1,20	MP210-8AL40/..
0.6	0,2	47,5 ± 2,0	-	-	2,00	MP210-8CAL12/..

ACTUATOR SERIES 8C

Identical to actuators of series 8 except that in this case they are fitted with a diam. 12mm roller and a return spring in the actuator arm the radius of which is set at 65mm. Being of a «U» cross-section, this lever is more rigid over this length than the 8AL 63.5mm. The actuator can be supplied with the following types of roller :

	Designations
Standard	8CL12, 8CT12
Designation «A»	8CLA12, 8CTA12
Designation «BZ»	8CLBZ12

In the case of variants «A» and «BZ», the weight of the roller must be taken into account in calculating switching speed and frequency. The roller must be eased back to the free position to avoid bounce.

SERIES MP320 & DERIVATIVES

MP320

SEALED MINIATURE MICROSWITCH IP67

The MP320 miniature microswitch is a snap-action changeover simple break with the connection cable directly over-moulded into the housing.

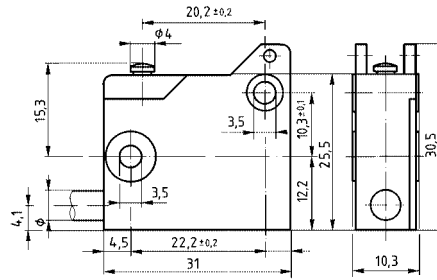

GENERAL CHARACTERISTICS, TYPE MP320

Approvals	: 
depending on the version	: CSA
Degree of protection	: IP67
Class of protection	: II
Micro-switch	: μ
Contact-gap	: 0.8 mm
Standards	: EN61058-1:92 + A1:93
Frequent functioning	: 50 E3
Mechanical life	: 50×10^6 operations
Snap-action mechanism	: Beryllium coppers leaf spring with self-cleaning contact.
Actuators	: Overall dimensions in stainless steel.
Dimensions	: DIN 41 635, form A

SWITCHING CAPACITY

Depending on the material of the electrical contacts and the cross-section of conductors.

Approvals			CSA
Cross-section of conductors	0.75 mm ²	0.50 mm ²	AWG 18
Ag contacts	6A 250VAC	2A 250VAC	6A 250VAC
Gold-plated contacts	0,1A 24VAC/DC		

REFERENCE CODE OF THE ARTICLE

SERIES MP320 & DERIVATIVES

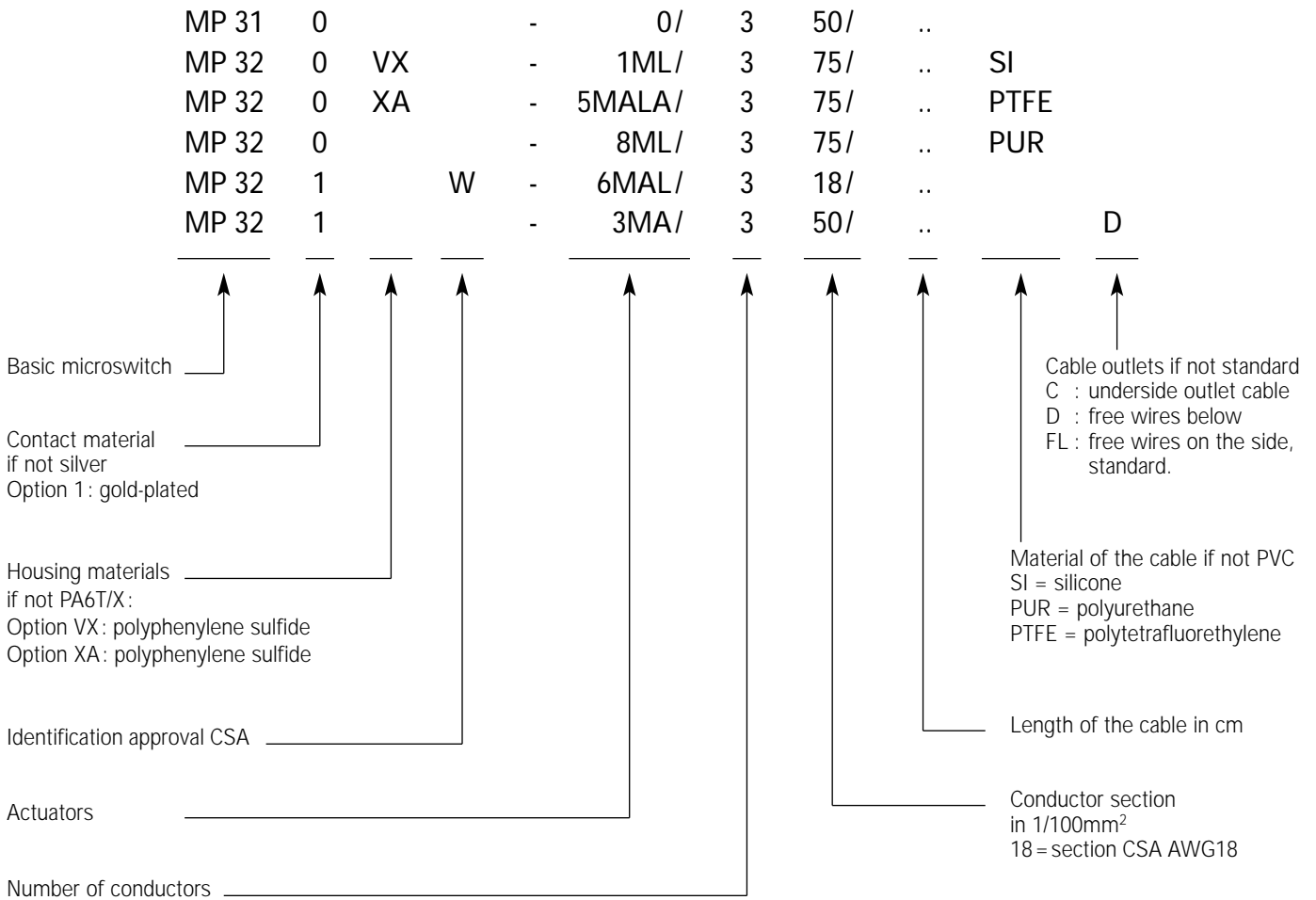

Housing:	PA6T/X reinforced with glass fibre	- 40°C to + 130°C
	Auto-extinguishing according to UL94V-O	- 40°C to + 130°C
	VX PPS reinforced with glass fibre	- 40°C to + 150°C
	Auto-extinguishing according to UL94V-O	- 40°C to + 150°C
Membrane:	XA PPS reinforced with glass fibre	- 40°C to + 200°C
	Auto-extinguishing according to UL94V-O	- 40°C to + 200°C
	Certified temperature	- 40°C to + 200°C
Cable:	Fluorsilicone rubber MFQ	- 40°C to + 175°C
	Variant XA (Membrane SI)	- 40°C to + 200°C
	PVC	- 20°C to + 70°C
	SI Silicone rubber	- 40°C to + 150°C
Free wires:	PUR polyurethane rubber	- 40°C to + 90°C
	PTFE polytetrafluorethylene	- 40°C to + 200°C
	PVC-CSA TR64 AWG18	- 40°C to + 105°C
	RXL155, outlets D or FL (without identification)	- 55°C to + 155°C

CONNECTION

By cables or supple wires

Cable with standard outlet



Examples :

- MP320-0/375/100SI
- MP320-0/375/200
- MP320-5MAL/375/100PUR
- MP321-6MAL/375/80
- MP320VX-5MALA/375/500SI
- MP320XA-1ML/375/100PTFE

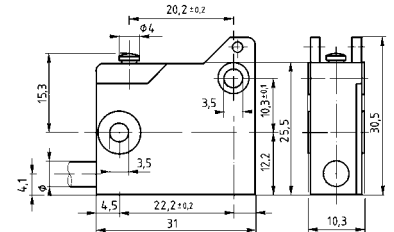

Underside cable outlet «C»



Examples :

- MP320-1MS27/375/50PURC
- MP320-3MB/375/200C

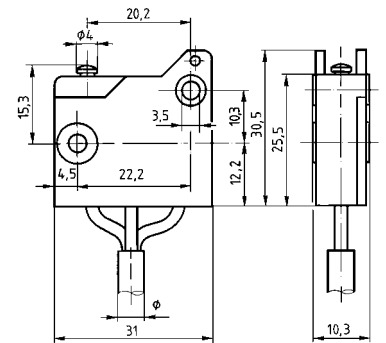

Independent wire connection, underside outlet «D» Independent wire connection, approval CSA



Examples :

- MP320-0/375/50D
- MP320-1MPSI/375/100D
- MP320W-5MAL/318/50D

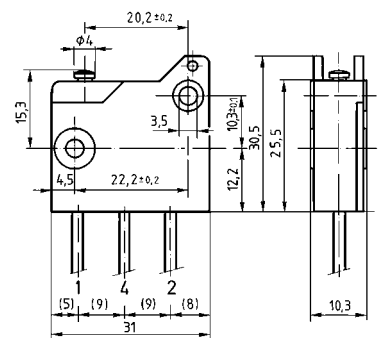

WIRING DIAGRAM

In relation with the type of the cable, the independent wires and the actuators

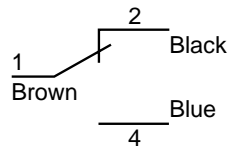
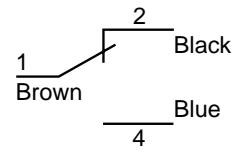
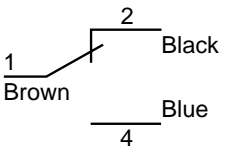
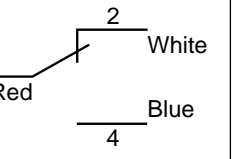
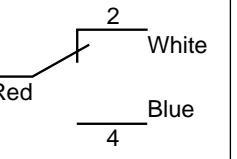
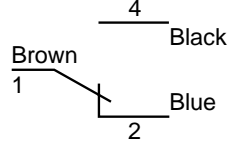
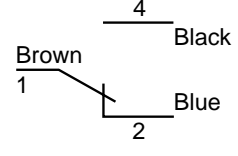
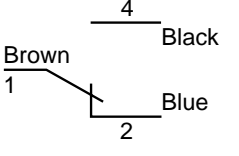
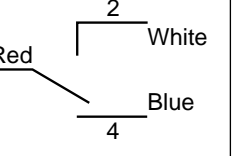
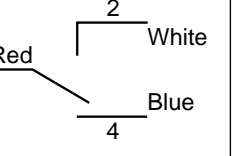
Isolating materials	PVC & RXL155	PTFE	Polyurethane	Silicone	CSA-PVC
Code in the reference of the article		PTFE	PUR	SI	../318/..
Without actuator «0» or type 1M..., 7M..., 8M...					
Reverse levers, types 3M..., 5M..., 6M...					

According to the availability of the market we reserve ourselves the right to modify the colors of identification of wire connection.

ACTUATING FORCE Fa max. (N)	RELEASE FORCE Fr min (N)	FREE POSITION Pr (mm)	OPERATING POSITION Pa (mm)	OVER-TRAVEL sr min. (mm)	DIFFERENTIAL MOVEMENT sd max. (mm)	DESIGNATION
3,5	1,0	15,3 ± 0,3	14,7 ± 0,2	0,2	0,07	MP310-0/..
3,5	1,0	15,3 ± 0,3	14,7 ± 0,2	0,2	0,07	MP320-0/..

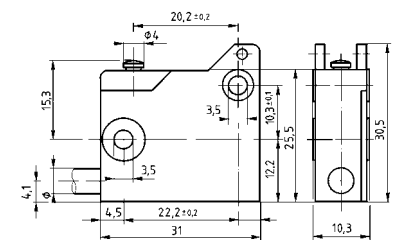
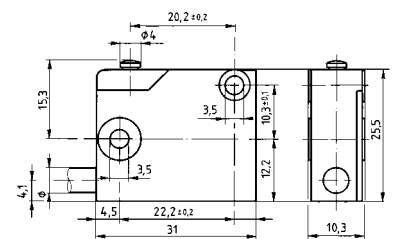

* **1MPN**: Chloroprene protective sleeve
 ** **1MPSI**: Silicone protective sleeve

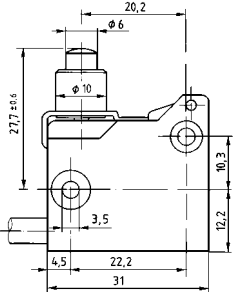
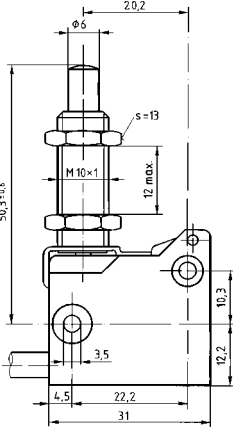
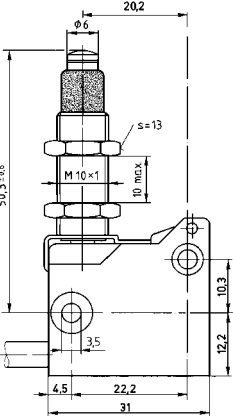
DESIGNATION	ACTUATING FORCE Fa max. (N)	RELEASE FORCE Fr min (N)	FREE POSITION Pr (mm)	OPERATING POSITION Pa (mm)	OVER-TRAVEL sr min. (mm)	DIFFERENTIAL MOVEMENT sd max. (mm)
 <p>MP320-1MS27/..</p>	3,5	1,0	27,7 ± 0,6	27,2 ± 0,3	2,0	0,10
 <p>MP320-1M/..</p>	3,5	1,0	50,3 ± 0,6	49,7 ± 0,3	5,0	0,10
 <p>* MP320-1MPN/.. ** MP320-1MPSI/..</p>	4,0	1,0	50,3 ± 0,6	49,7 ± 0,3	3,0	0,10

ACTUATING FORCE Fa max. (N)	RELEASE FORCE Fr min (N)	FREE POSITION Pr (mm)	OPERATING POSITION Pa (mm)	OVER-TRAVEL sr min. (mm)	DIFFERENTIAL MOVEMENT sd max. (mm)	DESIGNATION
3,5	1,0	49,8 ± 0,6	49,3 ± 0,3	5,0	0,10	MP320-1ML/..
3,5	1,0	49,8 ± 0,6	49,3 ± 0,3	5,0	0,10	MP320-1MT/..
2,5	1,0	26,0 ± 1,0	24,2 ± 0,6	2,5	0,80	MP320-3MA/..
2,5	1,0	26,0 ± 1,0	24,2 ± 0,6	2,5	0,80	MP320-3MB/..

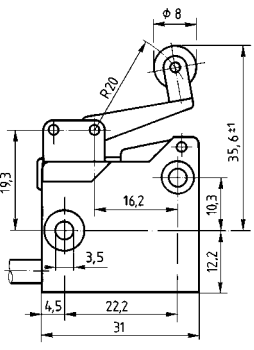
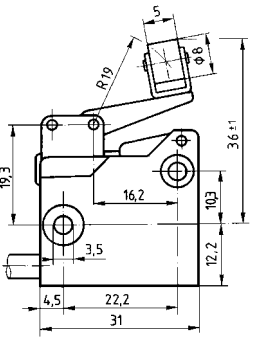
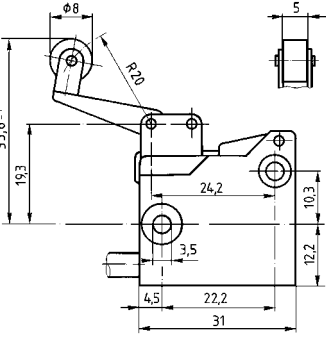
DESIGNATION	ACTUATING FORCE Fa max. (N)	RELEASE FORCE Fr min (N)	FREE POSITION Pr (mm)	OPERATING POSITION Pa (mm)	OVER-TRAVEL sr min. (mm)	DIFFERENTIAL MOVEMENT sd max. (mm)
 <p>MP320-5MAL/..</p>	3,0	1,0	35,6 ± 1,0	34,0 ± 0,6	2,5	0,80
 <p>MP320-5MAT/..</p>	3,0	1,0	36,0 ± 1,0	34,4 ± 0,6	2,5	0,80
 <p>MP320-5MBL/..</p>	3,0	1,0	35,6 ± 1,0	34,0 ± 0,6	2,5	0,80

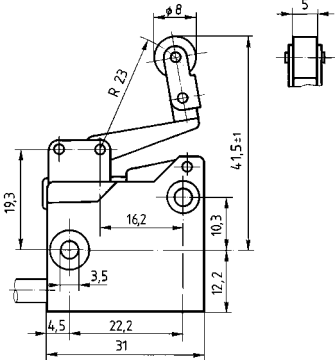
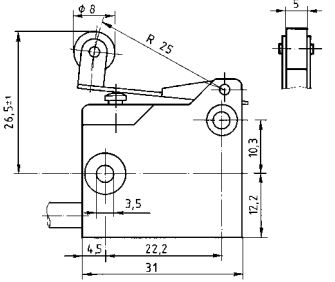
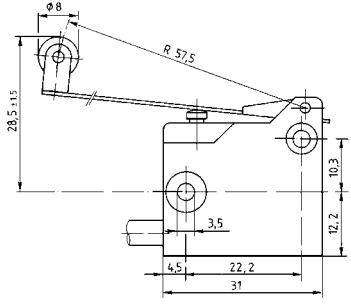
ACTUATING FORCE Fa max. (N)	RELEASE FORCE Fr min (N)	FREE POSITION Pr (mm)	OPERATING POSITION Pa (mm)	OVER-TRAVEL sr min. (mm)	DIFFERENTIAL MOVEMENT sd max. (mm)	DESIGNATION
3,0	1,0	41,5 ± 1,0	39,8 ± 0,6	2,5	0,80	MP320-6MAL/.. 
3,5	1,0	26,5 ± 1,0	25,7 ± 0,3	0,2	0,10	MP320-8ML25/.. 
1,3	0,3	28,5 ± 1,0	26,2 ± 0,8	0,5	0,80	MP320-8ML/.. 

SERIES MP420 & DERIVATIVES

MP420

SEALED SUB-MINIATURE MICROSWITCH IP67

The sealed sub-miniature MP420 microswitch is a simple snap-action changeover switch, which is connected by means of a cable directly, overmoulded into the housing.

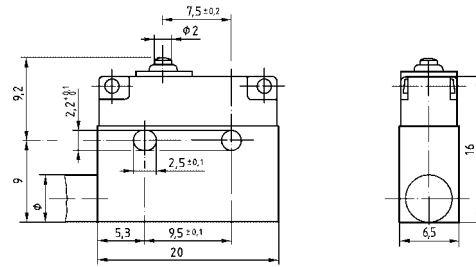

GENERAL CHARACTERISTICS, MP420 TYPES & DERIVATIVES

Approval	: ASE
Degree of protection	: IP67
Class of protection	: II
Micro-switching	: μ
Contact-gap	: 0,4 mm
Up to standard	: EN61058 identical to VDE0630
Frequent functioning	: 50E3
Mechanical life	: 50×10^6 operations
Snap-action mechanism	: Stainless steel traction spring with beryllium copper contact leaf, self-cleaning contacts.
Dimensions	: DIN 41 635, B-form
Actuators	: Stainless steel

Lever actuators snap on to the MP420 microswitch by pressing the lever onto the lugs on the housing. When doing this, care has to be taken not to break the lugs. Check to ensure that the actuator is properly positioned on the lugs and that the lever pivots without rubbing.

CONNECTIONS cable or free wires depending on the type

Isolating material	PVC	RXL155	PVC
Code in the reference of the article	MP430	MP440	MP450
Cable	X		X
Free wires		X	

REFERENCE CODE OF THE ARTICLE

SERIES MP420 & DERIVATIVES

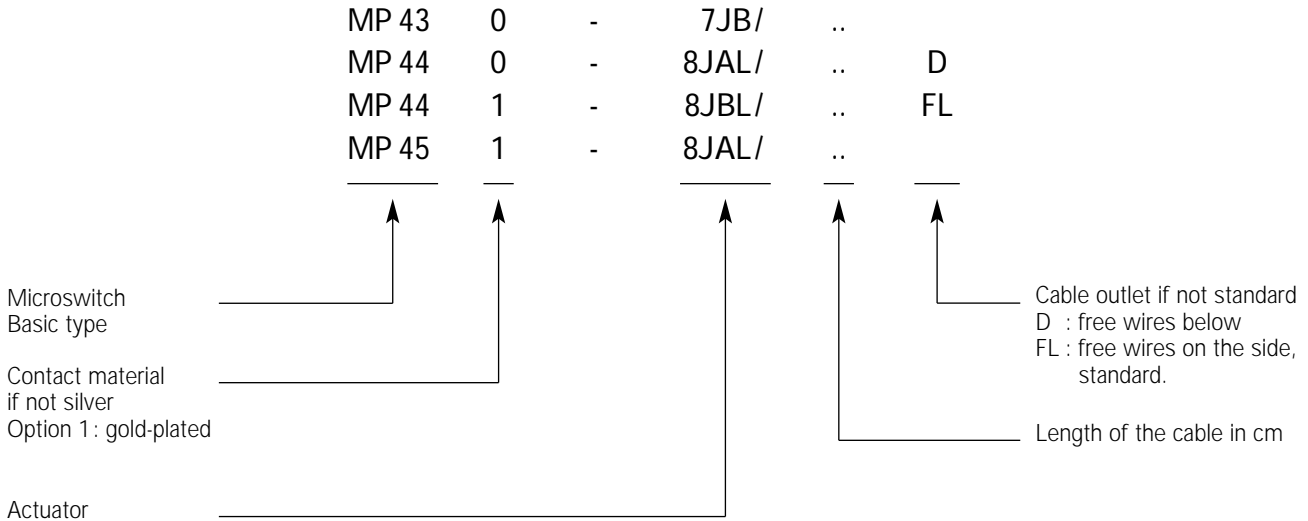

Housing:	PBT-ASA reinforced with glass fibre Auto-extinguishing according to UL94V-O	- 40°C to + 130°C
Membrane:	Fluorsilicone rubber MFQ	- 40°C to + 175°C
Cable:	PVC, grey sheath	- 20°C to + 70°C
Free wires:	RXL155, outlet D or FL (without identification)	- 55°C to + 155°C

REFERENCE OF THE ARTICLE, SWITCHING RATING AND WIRING DIAGRAM

Depending on the material of the electrical contacts and on the section of the conductors

Reference of the article	MP430	MP440	MP450
Section of the conductors	0.34 mm ²	0.25 mm ²	0.14 mm ²
Ag contacts	2A 250VAC	2A 250VAC	1A 250VAC
Gold-plated contacts	0,1A 24VAC/DC		
Wiring diagram			

REMARK:
The variant MP420, section of the conductors 0,50 mm² is cancelled, the demanded cable diameter is too big.

CONNECTION

By cables or supple wires

Cable with standard outlet

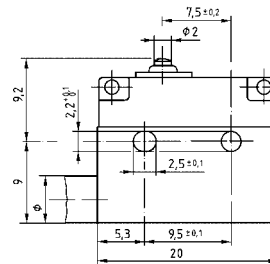

Examples :

- MP430-0/150
- MP450-0/200
- MP451-0/50

**Independent wire connection,
standard side-outlet «FL»**

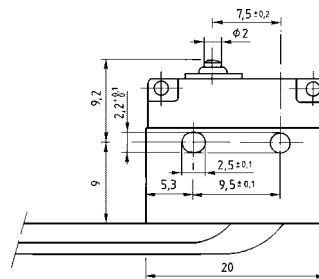

Examples :

- MP440-0/50FL
- MP441-0/100FL

**Independent wires,
underside outlet «D»**

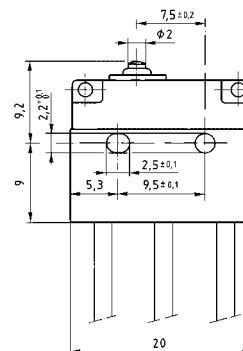

Examples :

- MP440-0/50D
- MP441-0/100D

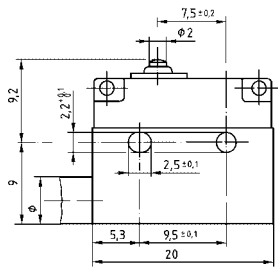
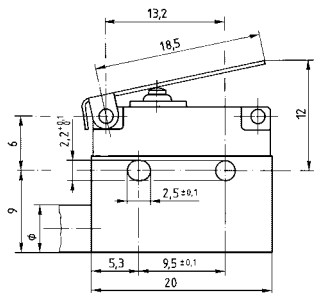
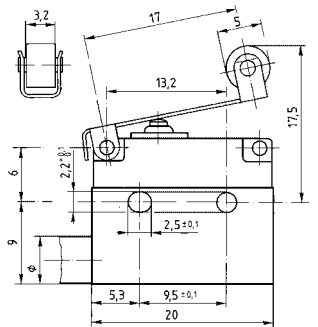
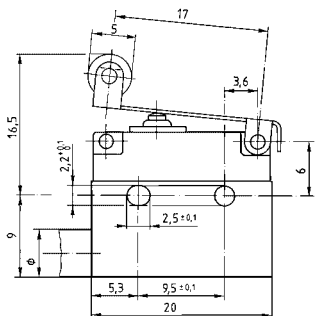
ACTUATING FORCE Fa max. (N)	RELEASE FORCE Fr min (N)	FREE POSITION Pr (mm)	OPERATING POSITION Pa (mm)	OVER-TRAVEL sr min. (mm)	DIFFERENTIAL MOVEMENT sd max. (mm)	DESIGNATION
2,5	0,5	9,2	8,4 ± 0,3	0,6	0,15	<p>MP430-0/.. MP450-0/..</p> 
1,0	0,15	12,0	9,0 ± 1,0	1,2	0,60	<p>MP430-7JA/.. MP450-7JA/..</p> 
1,0	0,15	17,5	14,8 ± 1,0	1,2	0,60	<p>MP430-8JAL/.. MP450-8JAL/..</p> 
2,0	0,3	16,5	14,5 ± 0,6	0,8	0,40	<p>MP430-8JBL/.. MP450-8JBL/..</p> 

SERIES MP720 & DERIVATIVES



MP720

SEALED POSITION SWITCH WITH POSITIVE OPENING OPERATION OVERMOULDED CABLE - DEGREE OF PROTECTION IP67

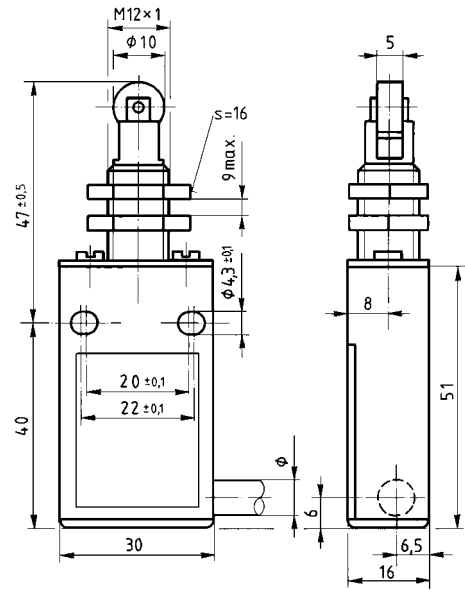
The MP720 positive opening position switch is a dependent-action, changeover, double-gap, contact element, which is connected by means of a cable directly overmoulded into the housing.



GENERAL CHARACTERISTICS, MP720 TYPES

Approvals	: VDE SUVAPro N° E6204.d
Nominal switching capacity	: 6A 250VAC
Degree of protection	: IP67
Class of protection	: II
Reinforced insulation	: 
Positive break	: 
Complies with standards	: EN60947-1 as VDE 0660 part 100 EN60947-5 as VDE 0660 part 200
Mechanical life	: 10×10^6 operations
Frequency of operation	: 3600 operations per hour
Type of use	: AC15 (3A 240VAC) DC13 (0.27A 250VDC)
Assigned insulation voltage U_i	: 250VAC
Electrical protection	: 6A gl according to VDE 0636
Connection	: Cable directly overmoulded to the housing section $4 \times 0.75 \text{mm}^2$
Overall dimensions	: DIN43695, EN 50047 and NFC 63-145, class Y2

REFERENCE CODE OF THE ARTICLE

SERIES MP720 & DERIVATIVES

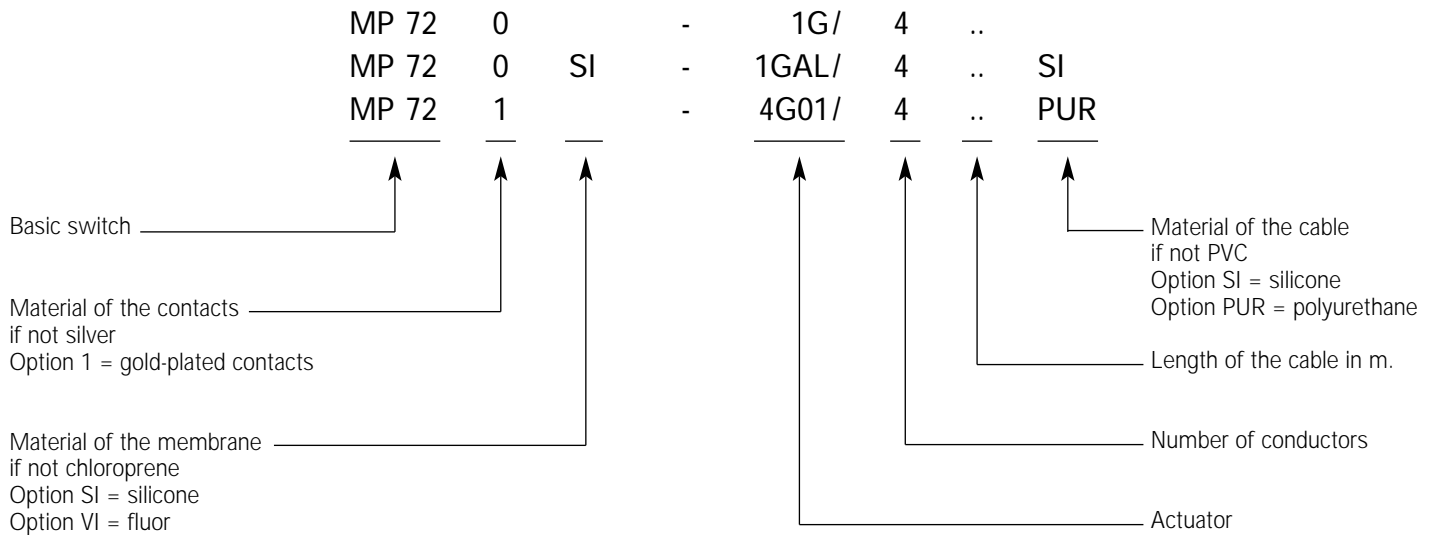

Housing:	PBT reinforced with glass fibre Auto-extinguishing according to UL94V-O - 40°C to + 130°C	
Sealing membrane:	Chloroprene rubber CR - 20°C to + 80°C SI Silicone rubber - 40°C to + 200°C VI Fluor rubber - 05°C to + 150°C	
Cable:	PVC - 20°C to + 70°C SI Silicone rubber - 40°C to + 150°C PUR polyurethane rubber - 40°C to + 90°C	

SWITCHING DIAGRAM Depending on the type of cable

Cable isolation	PVC	Polyurethane	Silicone
Code in the reference of the article		PUR	SI
Element of contact Za form			

According to the availability of the market we reserve ourselves the right to modify the colors of identification of wire connection.

11 - 12: Positive Break contact : positive opening operation.

23 - 24: Working contacts. They are designed for switching circuits and must never be used for breaking a safety circuit.

COMMAND CHARACTERISTICS TERMINOLOGY

Additional definitions for the MP720.

Pmp

Positive opening operation position. Actuator position at the point where the positive opening of the contacts is achieved.

Position of the actuator when the positive opening operation on the circuit-breaking contacts has been achieved. Position in, which pre-determined dielectric voltage rating requirements is met between the open contacts in the switchable circuit.

smp

Positive opening operation travel. The minimum distance between the start of the movement of the actuator and the position where the positive opening of the contacts is achieved.

Distance between the rest position and the positive opening operation position.

Fmp

Positive opening operation force. The actuating force applied to the actuator to cause it to achieve the positive opening operation.

SAMPLES APPLICATIONS

• Hinged door (rotating)

The problem with fitting a positive opening operation position switch to a hinged door is that the switch has to be operated as the door opens. Hence, the switch cannot be operated directly by the door but rather via a notched cam.

• Sliding door (lateral movement)

In this case also the switch has to be operated as the door opens. Care has to be taken to ensure that the positive opening operation switch remains in that position during the full open travel of the door.

Protective doors of this type are generally used on machines operating at high revolutions with cooling fluids. Consequently, it is essential in such applications that a switch with IP67 protection be used.

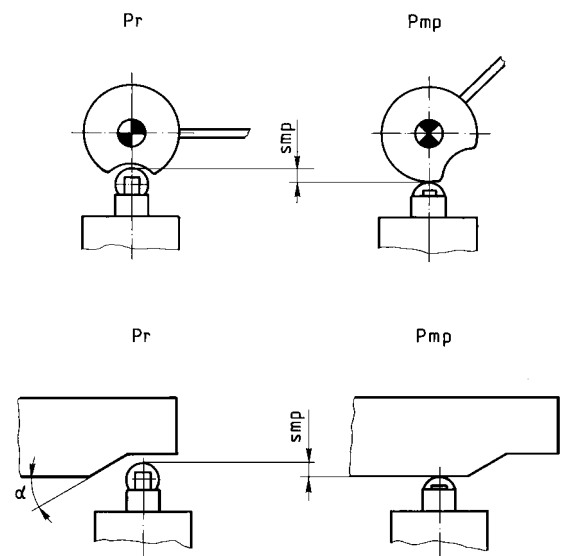

FITTING INSTRUCTIONS

Additional instructions supplementing those on page 6 to 15.

When fitting **MP720** positive opening operation position switches, account has to be taken of the following points:

- The switch **must be actuated with the minimum positive opening operation travel (smp)** given for each type of actuator. This travel insures the opening of the contacts, hence the interruption of the circuit.
- The switch must be secured to a rigid support. Care must be taken to ensure that the retaining screws cannot work loose in use.
- The cam must be positioned and insured against maladjustment.
- The actuators must be set at the proper angle to avoid the accumulation of foreign bodies.
- Components must be correctly selected according to temperatures and chemical resistance.

DOMED PLUNGER

The actuator must be operated axially.
Vertical button operating speed >1mm/s.

ACTUATING FORCE Fa max. (N)	POSITIVE OPENING FORCE Fmp min. (N)	FREE POSITION Pr (mm)	POSITIVE OPENING OPERATION POSITION Pmp max. (mm)	DESIGNATION	
4,0	10,0	20,5 ± 0,5	16,60	MP720-1G/4..	
4,0	10,0	35,0 ± 0,5	31,10	MP720-1GA/4..	

Switching diagram

* = Positive opening operation travel (smp)

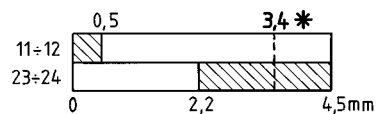

In free position, a clearance of 0.5 to 1.0 mm has to be left from the top of the actuating button.

The plunger **must not** be used as a mechanical endstop.

Plunger actuators with a M12x1 male threaded collar must be secured by that collar using the nuts provided for that purpose.

ROLLER PLUNGER

This may be operated by means of a rotating or sliding cam.
 A cam the **angles of which are in excess of 40°** or the speed of which is in excess of **2m/s** must not strike the roller plunger.
 The contact point must be directly above the axis of the roller.

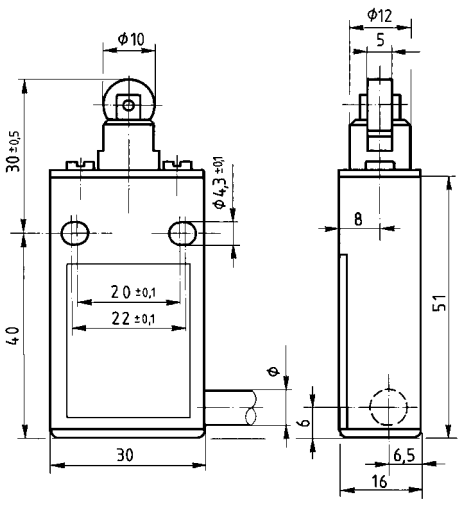
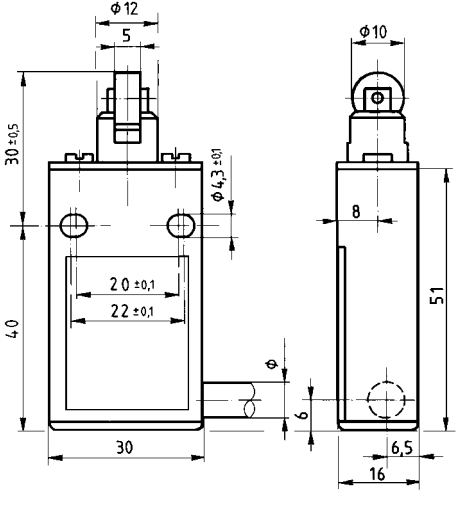
DESIGNATION	ACTUATING FORCE Fa max. (N)	POSITIVE OPENING FORCE Fmp min. (N)	FREE POSITION Pr (mm)	POSITIVE OPENING OPERATION POSITION Pmp max. (mm)
 <p>MP720-1GL/4..</p>	4,0	10,0	30,0 ± 0,5	26,10
 <p>MP720-1GT/4..</p>	4,0	10,0	30,0 ± 0,5	26,10

Switching diagram
 * = Positive opening operation travel (smp)

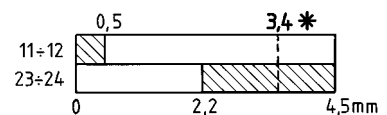

The strike angles and position must be so calculated as to avoid a violent shock to the roller;
 the cam must be so shaped as to ease the roller back to the free position.

4,0 10,0 47,0 ± 0,5 43,10

MP720-1GAL/4..

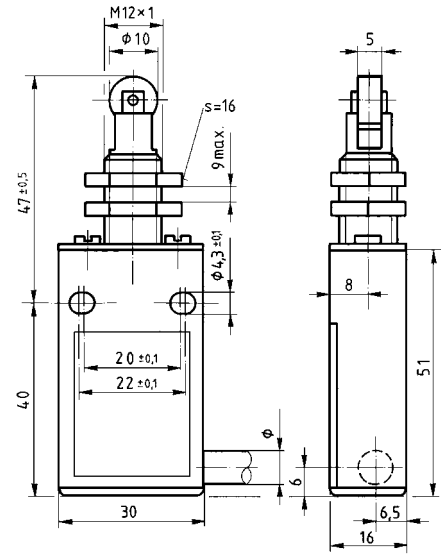

ACTUATING FORCE
Fa max. (N)

POSITIVE OPENING FORCE
Fmp min. (N)

FREE POSITION
Pr (mm)

POSITIVE OPENING
OPERATION POSITION
Pmp max. (mm)

DESIGNATION

ROLLER LEVER 4G

The actuator 4G is recommended for rapid movements although sharp movements and shocks to the roller should be avoided. The lever must be eased back to the free position.

Strike angle: 30°
Maximum speed: 5m/sec.

1,0 2,5 0° 58°

MP720-4G01/4..

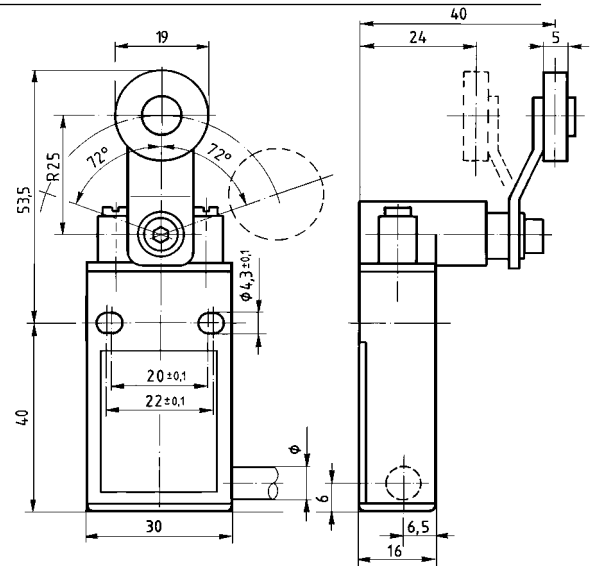

Switching diagram (4G..)

* = Positive opening operation travel (smp)

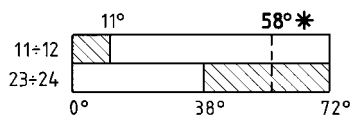

Reference of the article	Distance between the axis of the roller and the front face of the fixation screen
4G01	40 mm
4G02	24 mm
4G11	40 mm
4G12	24 mm



Microswitches and sealed position switches

If your application depends on it

SERIE **MP700**

- Plastic or metal case
- IP67 protection
- 30 mm or 35 mm case width
- Wide temperature range



Sealed limit switches



Serie MP700

The family MP700 of sealed limit switches with their metal or plastic housing finds their application everywhere you have limited space available and where the environmental conditions are difficult.

The products comply with IEC 947-5-1 and come with a choice of more than 10 different actuators. The cable is directly moulded into the housing for a complete IP67 protection.



Major specifications

- Metal or plastic housing
- 30 mm or 35 mm housing width
- Forced break switch with slow action or snap action
- Complete IP67 protection
- Ouvermoulded cable connection

General technical data

	MP720	MP730..MP760
Standards device confirms with	IEC 947-5-1	IEC 947-5-1
Operating Temperature	-40°C to +130°C -40°F to +266°F	-25°C to +70°C -13°F to +158°F
Degree of protection	IP67	IP67
Mechanical Life	10 million operations	10 million operations
Switching frequency	3600 operations per hour	3600 operations per hour
Switching Mechanism	forced break slow action	forced break slow action or snap action
RATING		
Conventional thermal current	6A	5A
Short circuit protection	6A	6A
Rated operational current	<ul style="list-style-type: none"> • 240VAC AC-15 3A • 250VDC DC-13 0.27A 	<ul style="list-style-type: none"> AC-15 1.5A DC-13 0.1A

MP7 0 0 - 0 - 0 / 4 2

Case

- 2** 130°C Version
- 3** plastic 30 mm
- 4** metal 30 mm
- 5** plastic 35 mm
- 6** metal 35 mm

Cable outlet

- 0** right
- 1** right gold plated°
- 2** left
- 3** down

Switching Block

- 0** X Slow Action
- 1** Y Snap Action°

Actuator

see pictures

Number of conductors (4 or 5)

Cable length in m (1 m standard)

Cable Material (PVC standard)

SI Silicone (upon request)

PUR Polyurethane (upon request)

° only available for 130°C version

° not available for 130°C version

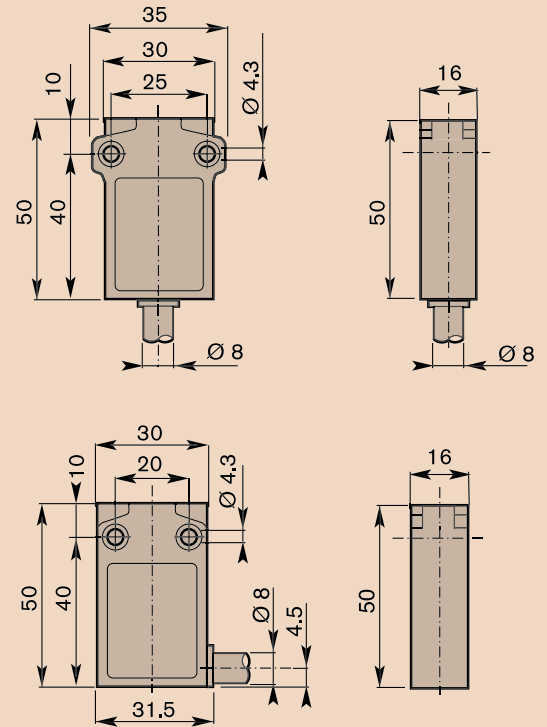

Actuators

*Standard roller in plastic (P), metal (A) also available



Trust more than 50 years of experience!

Companies, whose activities encompass such different areas as food processing, chemicals, machine-tools, transport, etc., have been placing their trust in Microprecision Electronics SA for a long time; they have found it to be a first-class and reliable partner, able to supply tailor-made products which meet international standards.

56 basic types and more than 1000 possible configurations allow virtually any application to be met in industries where harsh environments require the highest technological competence.

Microprecision Electronics SA has set itself the task of listening to its customers expectations so that it can provide tailor-made solutions from the small production runs.





SERIES MP500

- Connector industry PCB, solder terminal lugs or PVC cable
- Conforms to standard IP 67
- Silver or gold-plated contacts
- Wide choice of levers
- Operating temperature up to 130°C / 266 °F



Microswitches and sealed position switches

If your application depends on it



Operating Characteristics

	L00	L70	L71	L80	L81	L85	L86
Actuating force Fa max [N]	2.5	1.0	2.0	1.0	2.0	1.0	2.0
Release force Fr min [N]	0.5	0.15	0.3	0.15	0.3	0.15	0.3
Free position Pr [mm]	9.2	12.0	11.0	17.5	16.5	16.0	17.0
Operating position Pa [mm]	8.4+/-0.3	9.0+/-1.0	8.8+/-0.6	14.8+/-1.0	14.5+/-0.6	14.0+/-1.0	13.7+/-1.0
Repetitivity [mm]	+/-0.02	+/-0.04	+/-0.04	+/-0.04	+/-0.04	+/-0.04	+/-0.04
Over-travel sr min [mm]	0.6	1.2	0.8	1.2	0.8	1.2	0.8
Differential movement sd [mm]	0.15	0.6	0.4	0.6	0.4	0.6	0.4
Contact gap [mm]	0.4	0.4	0.4	0.4	0.4	0.4	0.4

Electrical characteristics

Switching rating

- contact silver: 250VAC - 6A - changeover
- gold-plated on silver: 24VAC/DC - 0.1A

Approvals: UL 1054

Standard	IP67
Terminals	Refer to opposite page
Ambient temperature	-40 °C to +105 °C (130°C: PCB + CS) -40 °F to 221 °F (266 °F: PCB + CS)

Other characteristics

Mechanism	Snap-action coil spring mechanism with stainless steel spring. Changeover.
Mechanical lifespan	10x10 ⁶ cycles
Housing	PA6T/X, reinforced with glass fibre, according UL94V-0
Dimensions	DIN 41 635, B-form
Membrane	Fluor-silicone rubber MFO
Cable	PVC, 0.25mm ² , UL Style 2103 (Max. 3A)
Actuators	Stainless steel, refer to opposite page



Ordering Reference

MP50 - **L** - **C**



0 Silver contact

1 Gold-plated contact



00 Without lever

The lever can be assembled in 2 ways:

70 Lever 7 position A

A: fixing close to the button

71 Lever 7 position B

B: fixing to the opposite of the button

80 Lever 8 position A

81 Lever 8 position B

85 Simulated roller- position A

86 Simulated roller- position B



000 Solder terminals -40°C + 130°C / -40°F + 266°F

001 PCB -40°C + 130°C / -40°F + 266°F

100 50 cm PVC cable -40°C + 105°C / -40°F + 221°F

Other lengths on request

Layout PCB



PVC

MP500 - L - C100

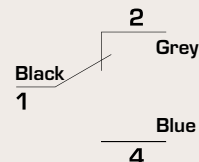

CS

MP500 - L - C000

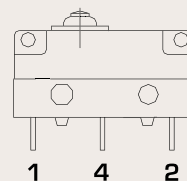

PCB

MP500 - L - C001

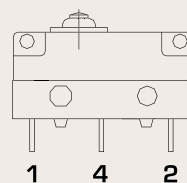

Examples of connector industries (C)

MP500 - L00 - C000

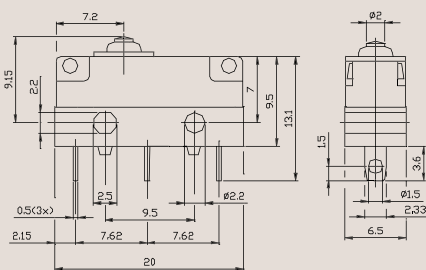

MP500 - L00 - C100

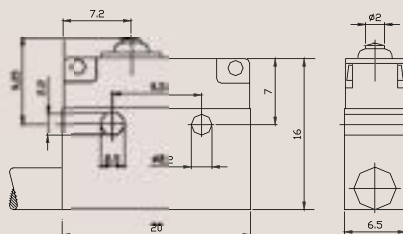

MP500 - L00 - C001

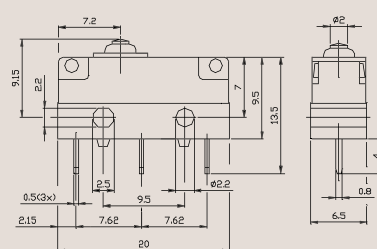

Examples of levers (L)

MP500 - L70

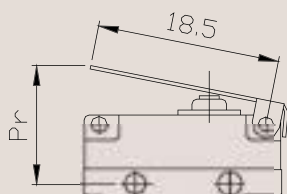

MP500 - L80

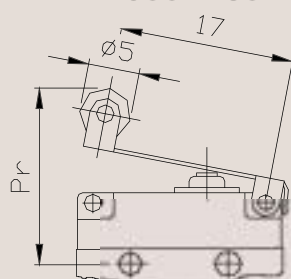

MP500 - L85

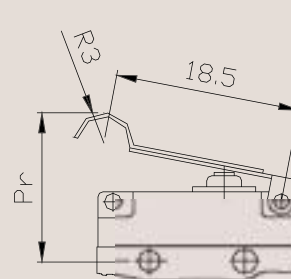

Trust more than 50 years of experience!

Companies, whose activities encompass such different areas as food processing, chemicals, machine-tools, transport, etc., have been placing their trust in Microprecision Electronics SA for a long time; they have found it to be a first-class and reliable partner, able to supply tailor-made products which meet international standards.

56 basic types and more than 1000 possible configurations allow virtually any application to be met in industries where harsh environments require the highest technological competence.

Microprecision Electronics SA has set itself the task of listening to its customers expectations so that it can provide tailor-made solutions from the small production runs.

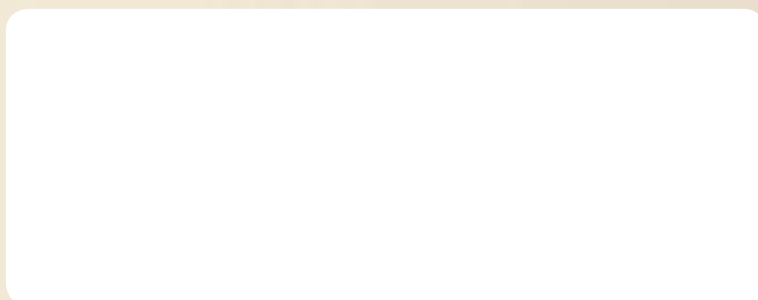



Microswitches and sealed position switches

If your application depends on it

SERIES **MP800**

- Plastic or metal case
- IP65-66 protection
- 30 mm, 40 mm or 50 mm case width
- Forced break switches with slow action or snap action

Safety and limit switches



Series MP800

The family MP800 of safety and limit switches with their metal or plastic housing are ideally suited to application where precise shutdown is required. For example when the positions of doors and access hatches are monitored.

They can be used in safety circuits as the NC contact is positively-opening in compliance with IEC 60 947-5-1.



Major specifications

- Metal or plastic housing
- Forced break switch with slow action or snap action
- IP65 or 66 protections
- Positive opening operation for NC contacts
- Standards: UL – CSA
- Large selection of actuating heads

General technical data

	MP800-MP810-MP850	MP820-MP830-MP870
Housing	Plastic	Metal
Standards device conforms with	IEC 947-5-1	IEC 947-5-1
Operating temperature	-25°C to +70°C/-13°F to +158°F	-25°C to +70°C/-13°F to +158°F
Degree of protection	IP65	IP66
Mechanical life	up to 30 million operations	up to 30 million operations
Switching frequency	3600 operations per hour	3600 operations per hour
Switching mechanism	forced break slow action or snap action	interruption forcée slow action or snap action
RATING		
Conventional thermal current	10A	10A
Short circuit protection	10A	10A
Rated operational current	<ul style="list-style-type: none"> • 240VAC AC-15 3A • 250VDC DC-13 0.27A 	<ul style="list-style-type: none"> AC-15 3A DC-13 0.27A

Dimensions (in mm)

EN 50 041

MP850

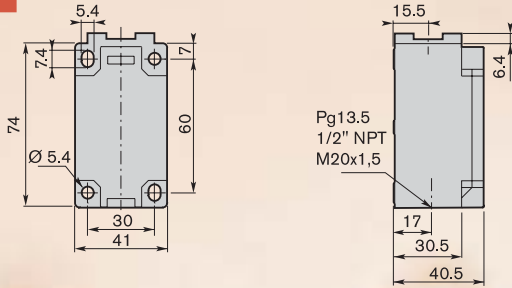

MP870

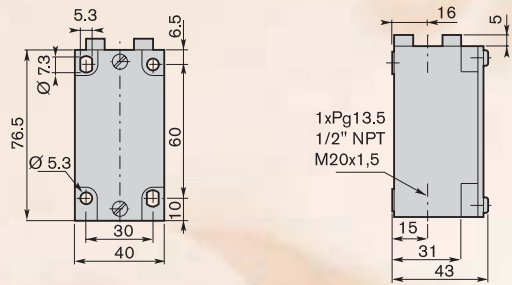

Dimensions (in mm)

EN 50 047

MP800

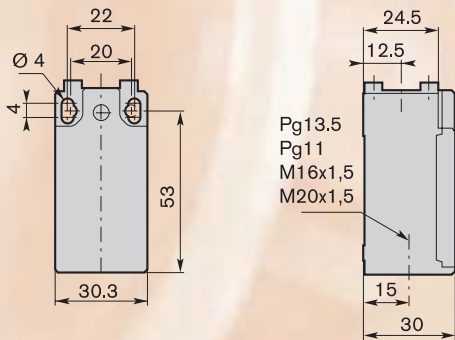

MP810

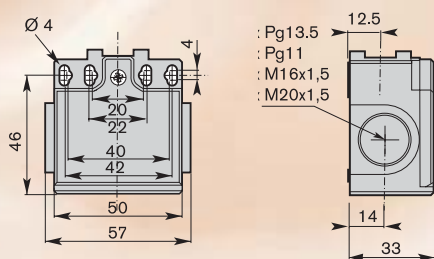

MP820

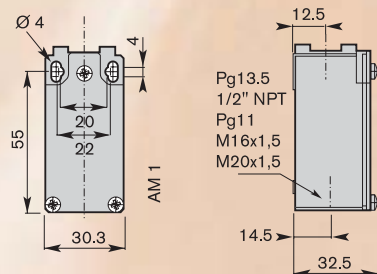

MP830

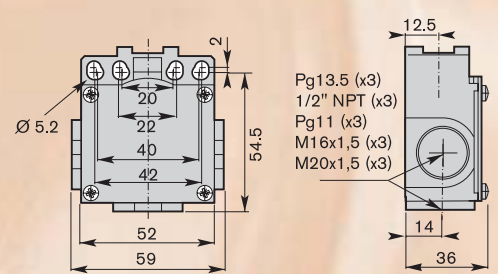

MP8 0 0 - 0 - 0 0 0 0

Case

EN 50 047

- 0 plastic 30 mm
- 1 plastic 50 mm
- 2 metal 30 mm
- 3 metal 50 mm

EN 50 041

- 5 plastic 40 mm
- 7 metal 40 mm

Opening

- 1 PG 13.5
- 2 1/2" NPT, with optional adapter (MP 810)
- 3 PG 11, only for EN 50 047
- 4 M16, only for EN 50 047
- 5 M20

Switching Block

- 1 Snap-action, 1NO+1NC
- 2 Snap-action, 2NC
- 3 Slow-action, non-overlapping, 1NO+1NC
- 4 Slow-action, overlapping, 1NO+1NC
- 5 Slow-action, 2NC
- 6 Slow-action, non-overlapping, 2NO+1NC
- 7 Slow-action, non-overlapping, 1NO+2NC
- 8 Slow-action, simultaneous, 3NC

Actuator

See pictures

Actuators

Limit switches

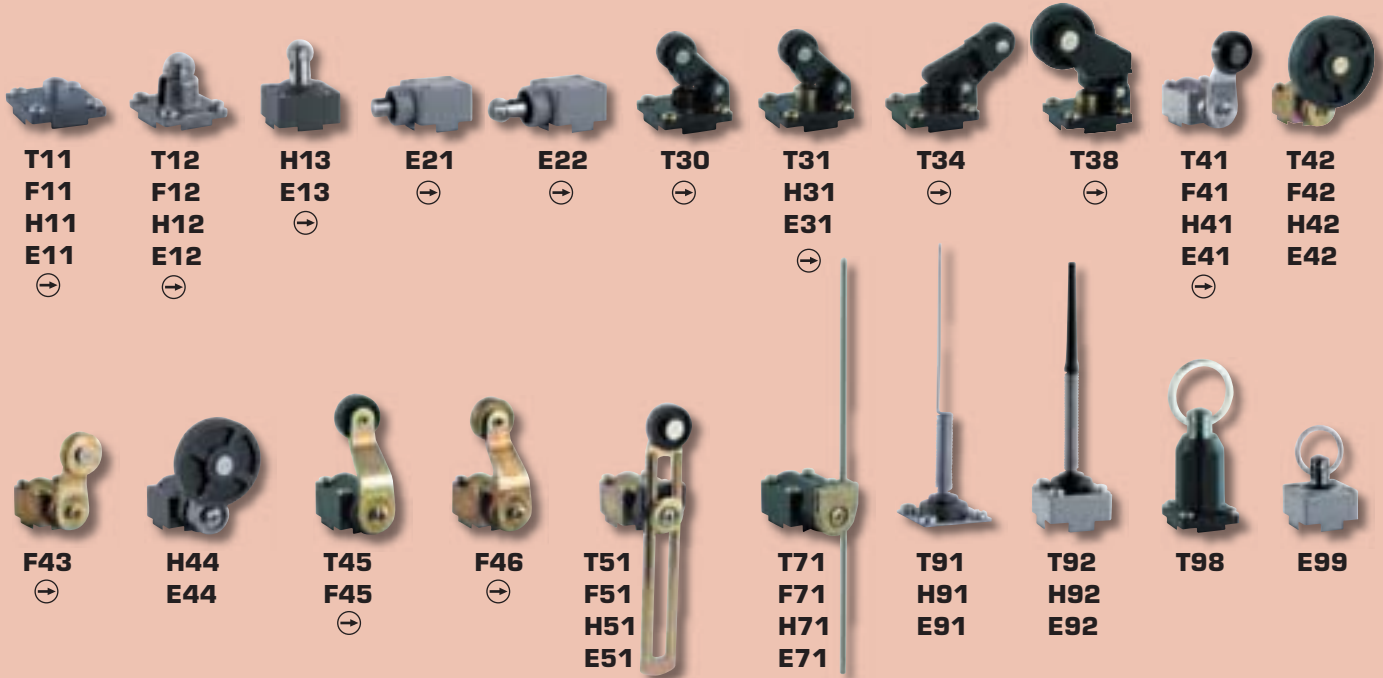

Safety limit switches



Operating keys (to be ordered separately)



- T** Plastic case EN 50 047
- F** Metal case EN 50 047
- H** Plastic case EN 50 041
- E** Metal case EN 50 041
- K** Safety limit switch

⊕ Positively-opening acc. to IEC 60 947-5-1

MP800 position switches

Ideally suited for rugged industrial applications

Wide product range

With a wide range of actuators in line with the functions that are required in the field, the MP800 position switches can be used to:

- Monitor protective devices with hinged joints, such as swivelling doors, hatches, covers, etc.
- Monitor protective devices which can be moved sideways, such as sliding doors, protective gates, etc.
- Detect hazardous machinery motion; dimensions, mounting locations and characteristic values, are to a large extent, in conformance with EN 50 041 and EN 50 047.

Positively-opening contacts (IEC 60947-5-1)

Positively-opening NC contacts are expressly specified for the electrical equipment of machines.

This is designated using the \ominus symbol in compliance with IEC 60 947-5-1 (personnel protection function).

Safety is done on contacts NC.

Examples of applications

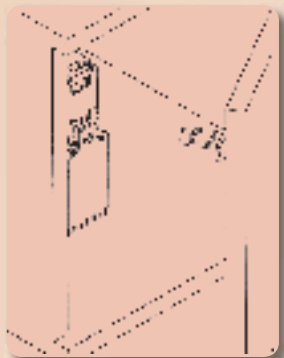

Key safety switch

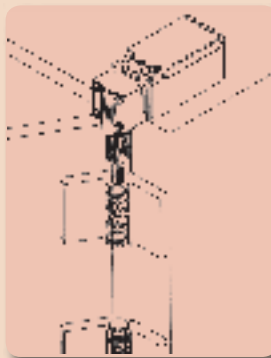

Shaft safety switch



Z lever safety switch



MICROPRECISION ELECTRONICS SA

P.O. Box 160 ▪ Route de l'Industrie 27
CH - 1896 VOUVRY ▪ SWITZERLAND
Tel: +41(0)24 481 43 43 ▪ Fax: +41(0)24 481 43 60
info@microprecision.ch ▪ www.microprecision.ch

Trust more than 50 years of experience!

Companies, whose activities encompass such different areas as food processing, chemicals, machine-tools, transport, etc., have long been placing their trust in Microprecision Electronics SA; indeed, they have found them to be a first-class and reliable partner, able to supply tailor-made products which meet international standards.

56 basic types of switches and more than 1000 possibilities let to you foresee the number of possible applications in industries where a harsh environment requires the highest technological competences.

Microprecision Electronics SA has set itself the task of listening to its clients' expectations so that it can provide them with tailor-made solutions from the production of small runs.

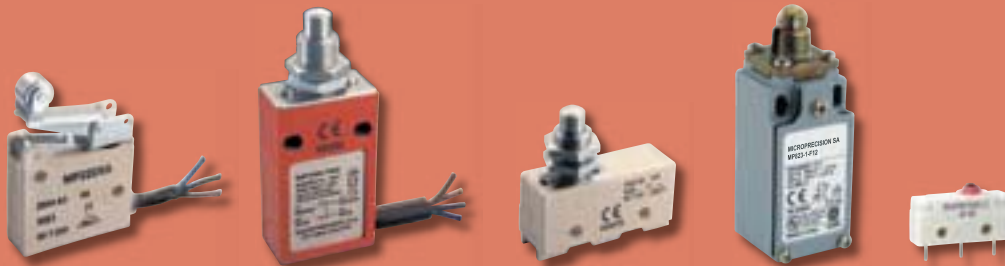

聯輝電子有限公司
新竹縣竹北市高鐵八路193號2樓
Tel: 03-667 2580
Fax: 03-667 2581
M: 0932 372 863
E-mail: gte.info@gmail.com
URL: www.gte.url.tw